

## SPECIFICATION

Part No. : **LMA100.A.BI.001**

Product Name : Gemini LTE 4G MIMO 2x2 Antenna for Routers and Access Points

Feature : Best solution for 4G 2x2 Worldwide LTE MIMO applications  
Covers fallback 2G/3G frequencies too  
(HSPA/UMTS/WCDMA/GSM/GPRS)  
698-960MHz,1710-2170MHz,2490-2690MHz  
High Efficiency Indoor and Outdoor Antenna  
Waterproof IP67  
Wall Mount or Desktop Mount  
Dimension: 164mm\*164mm\*36.5mm  
2\* Low Loss 1M CFD-200 Cables - SMA(M)  
Cable and connector customizable  
**RoHS compliant**



Wall Mount



## 1. Introduction

The Gemini LTE 4G MIMO 2X2 is a robust external antenna that is fully IP67 waterproof for use with all 2G/3G/4G MIMO cellular routers and Access points worldwide. It includes two embedded high efficiency LTE MIMO antennas. The antenna elements operate at all common and 4G LTE bands worldwide; 698-960MHz, 1710-2170MHz, 2490-2690MHz, which also include the 2G and 3G bands, meaning the antenna can also be used as fallback on 2G or 3G applications. High isolation and low ECC between the two embedded MIMO antennas prevents self-interference. Low loss cables are used to keep efficiency high over long cable lengths up to 5 metres.

This unique antenna offers two methods for easy installation, both indoors and outdoors. A bracket on the back of the antenna enables easy wall installation, keeping your work area clean and spacious. The antenna can also be placed on a flat surface using the stand holder for easy and quick installation.

### Typical Applications

HD Real-time Streaming Video over LTE

Intelligent Transport Systems

Internet of Things (IoT market)

Digital Signage

HD Broadcast Systems

Wireless 4G LTE MIMO M2M devices with legacy 3G Functionality

Cable length and connector types are customizable. Contact your regional Taoglas sales office for support.

## 2. Specification Table

2G/3G/4G MIMO1 Antenna								
Frequency (MHz)		LTE700	GSM850	GSM900	DCS	PCS	UMTS1	LTE2600
		698~824	824~894	880~960	1710~1880	1850~1990	1920~2170	2490~2690
Efficiency (%)								
MIMO1	0.3M	77.91	57.40	46.79	66.09	61.53	43.94	41.33
	1M	74.40	54.82	44.68	60.27	56.20	40.36	37.70
	2M	66.31	48.59	38.91	49.44	45.76	32.97	29.63
	3M	61.89	45.06	36.11	43.76	40.32	28.84	25.17
	5M	53.13	37.96	30.30	34.20	31.13	22.32	19.24
MIMO2	0.3M	73.17	46.21	37.12	71.80	59.28	45.79	45.25
	1M	69.88	44.13	35.45	65.48	54.17	42.14	41.27
	2M	62.28	39.09	30.87	53.75	44.11	34.45	32.49
	3M	58.12	36.23	28.63	47.54	38.89	30.14	27.63
	5M	49.90	30.55	24.07	37.19	30.01	23.33	21.11
Average Gain (dBi)								
MIMO1	0.3M	-1.12	-2.46	-3.32	-1.83	-2.20	-3.82	-3.92
	1M	-1.32	-2.66	-3.52	-2.23	-2.59	-4.18	-4.32
	2M	-1.82	-3.18	-4.12	-3.09	-3.48	-5.06	-5.36
	3M	-2.12	-3.51	-4.45	-3.62	-4.04	-5.64	-6.07
	5M	-2.79	-4.26	-5.20	-4.69	-5.16	-6.75	-7.23
MIMO2	0.3M	-1.42	-3.36	-4.35	-1.45	-2.37	-3.55	-3.48
	1M	-1.62	-3.56	-4.55	-1.85	-2.76	-3.91	-3.88
	2M	-2.12	-4.09	-5.15	-2.71	-3.65	-4.78	-4.92
	3M	-2.42	-4.42	-5.48	-3.24	-4.21	-5.37	-5.63
	5M	-3.08	-5.16	-6.23	-4.31	-5.33	-6.47	-6.80
Peak Gain (dBi)								
MIMO1	0.3M	4.76	3.42	3.07	4.68	4.68	4.20	2.41
	1M	4.56	3.22	2.87	4.28	4.28	3.80	2.01
	2M	4.06	2.72	2.27	3.38	3.38	2.90	1.01
	3M	3.76	2.42	1.97	2.88	2.88	2.30	0.31
	5M	3.16	1.62	1.17	1.78	1.78	1.20	-0.89
MIMO2	0.3M	4.62	2.94	2.89	5.04	5.12	5.08	2.20
	1M	4.42	2.74	2.69	4.64	4.72	4.68	1.80
	2M	3.92	2.24	2.09	3.74	3.82	3.78	0.80
	3M	3.62	1.84	1.79	3.24	3.32	3.28	0.10
	5M	3.02	1.14	1.09	2.14	3.32	2.08	-1.00
Impedance	50 Ω							
Polarization	Vertical							

<b>MECHANICAL</b>	
Casing	PC+ABS
Coaxial Cable	CFD-200
Cable Length	1 Meter Standard, Fully Customizable
Connector	SMA Male Standard, Fully Customizable
Waterproof	IP67
Weight	400 g (Antenna with 1 meter Cable and Stand)
Dimension	164mm*164mm*36.5mm
<b>ENVIRONMENTAL</b>	
Operation Temperature	-40°C to 85°C
Storage Temperature	-40°C to 85°C
Humidity	Non-condensing 65°C 95% RH

### 3. Antenna Characteristics

#### 3.1 Return Loss

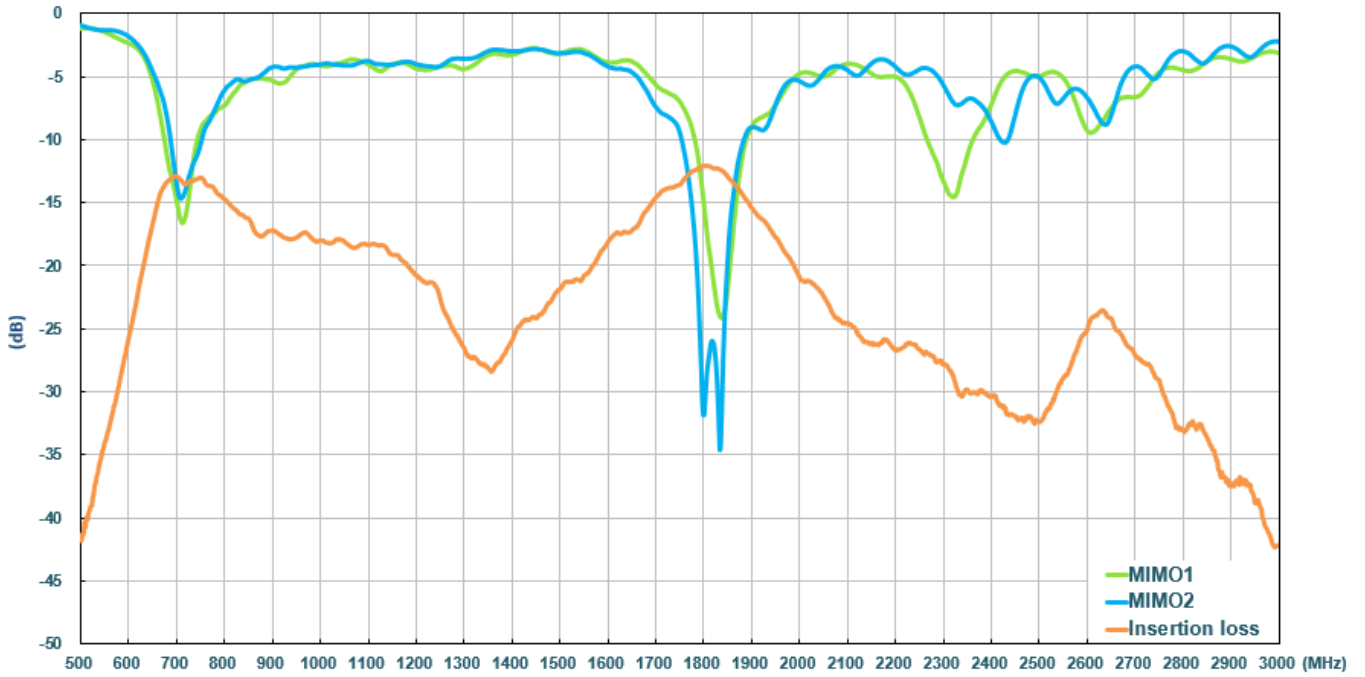

#### 3.2 Efficiency

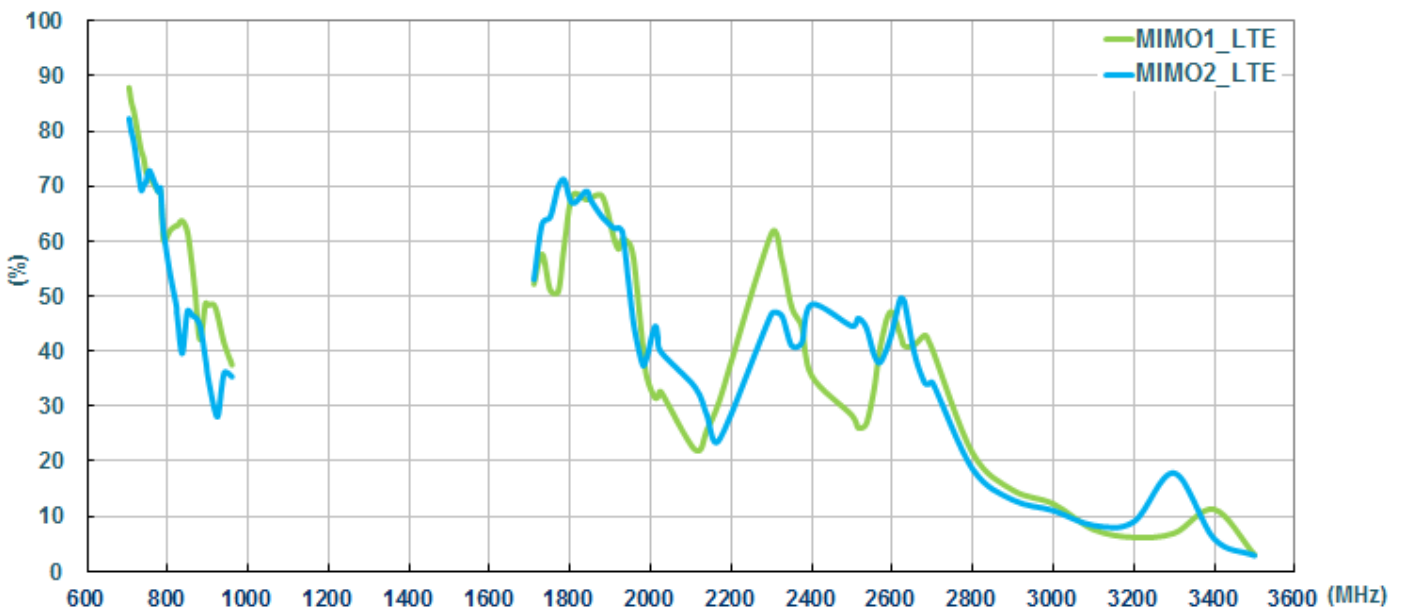

### 3.3 Average Gain

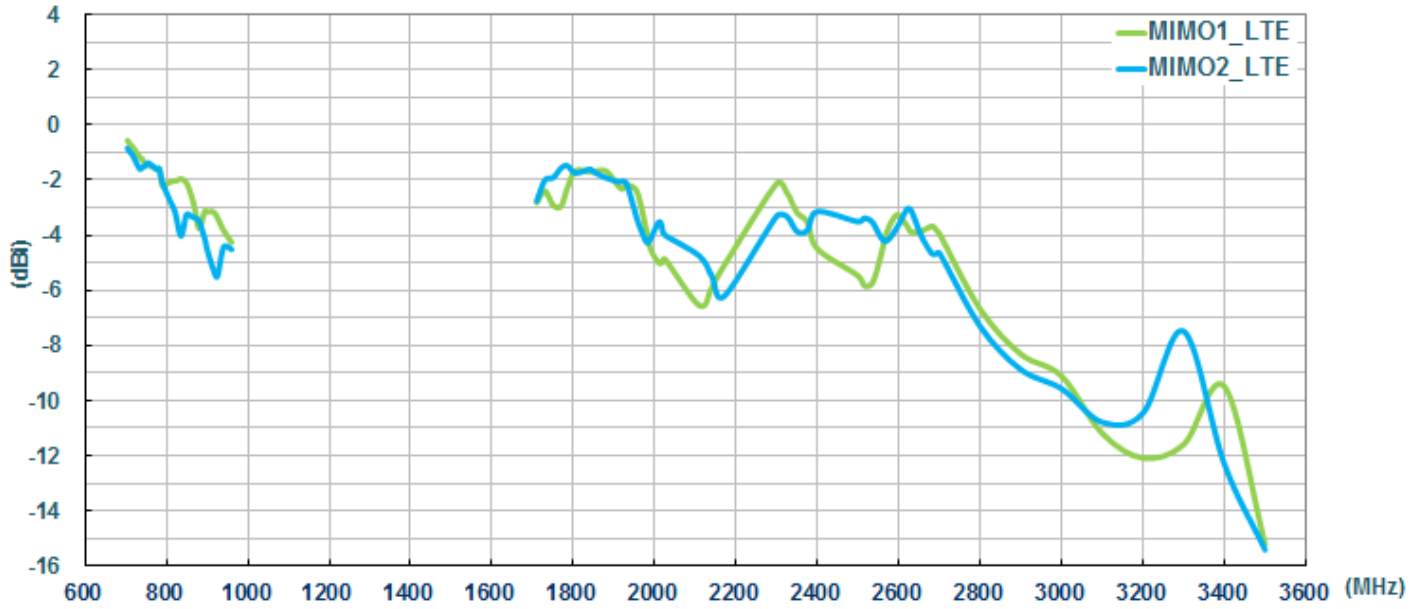

### 3.4 Peak Gain

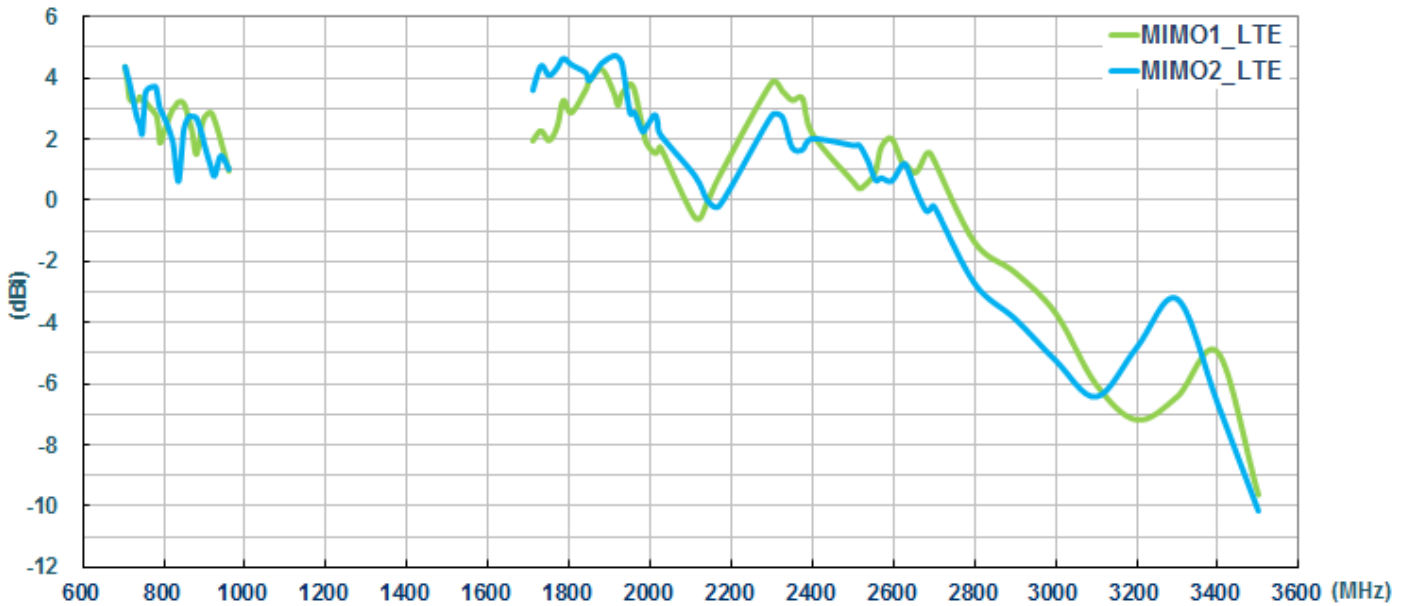

## 4. Radiation Patterns

### 4.1 Test Setup

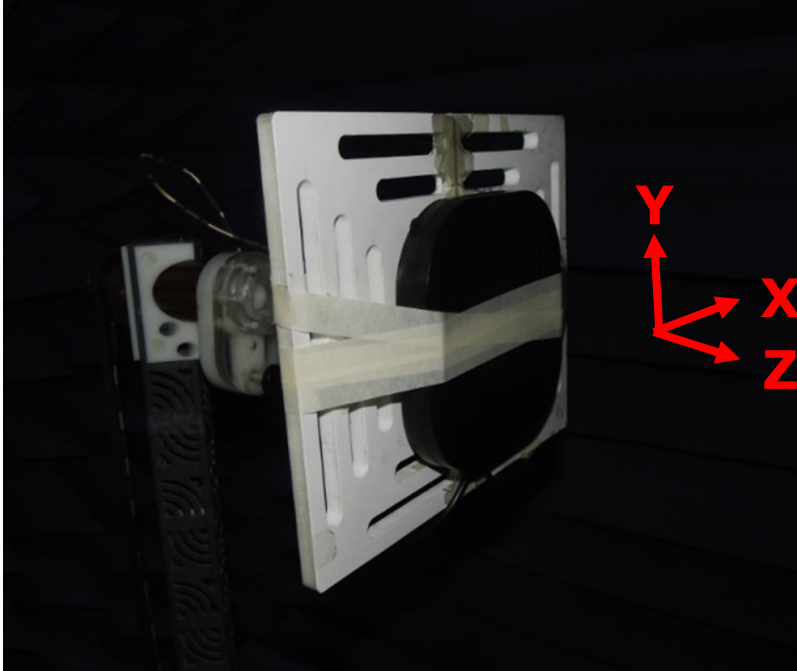

## 4.2 LTE MIMO1 (2D Radiation Pattern)

### 4.2.1 XY Plane

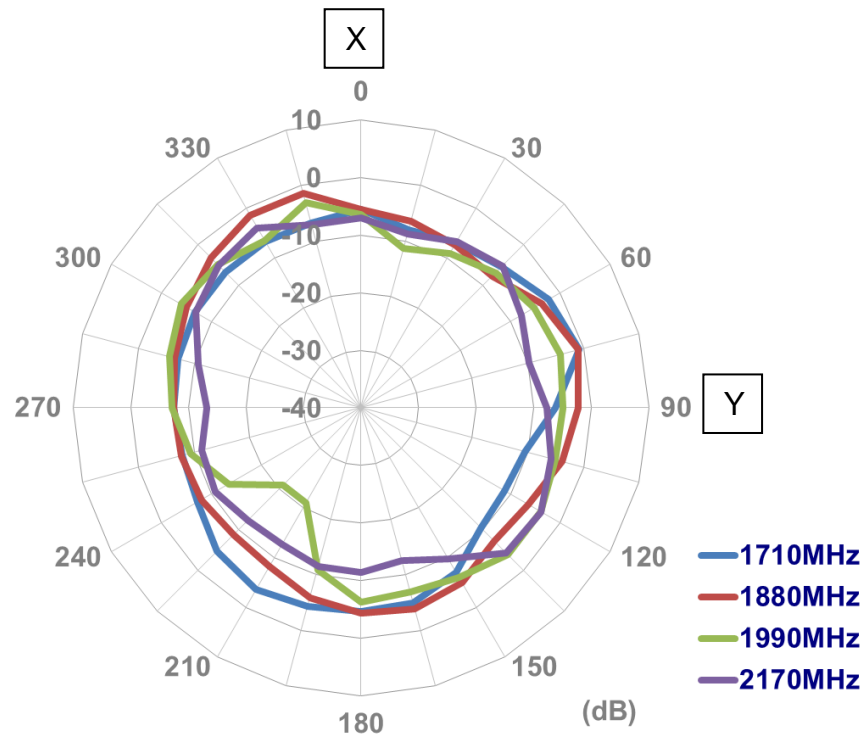
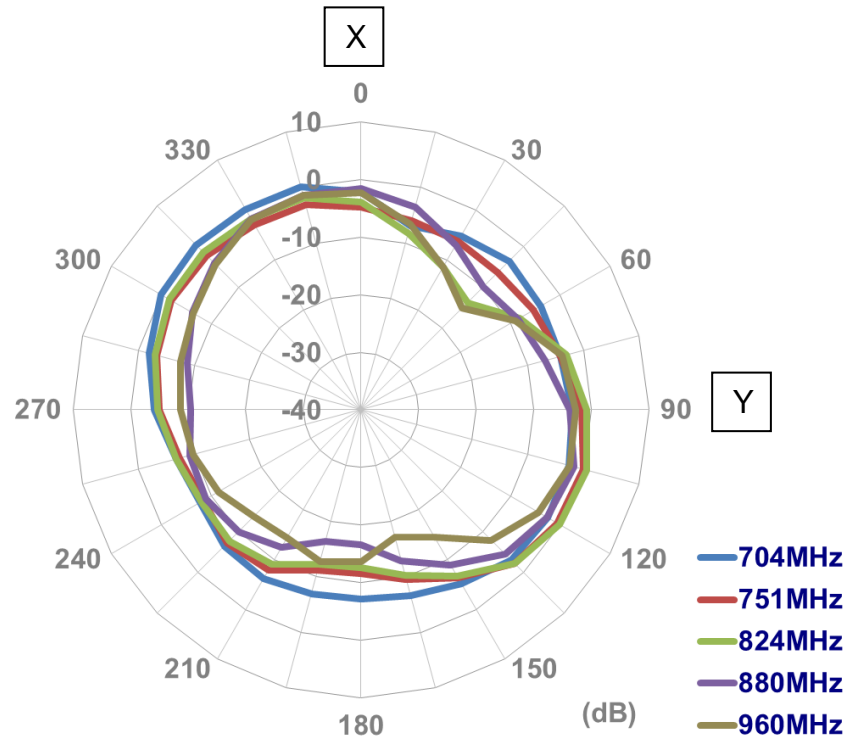



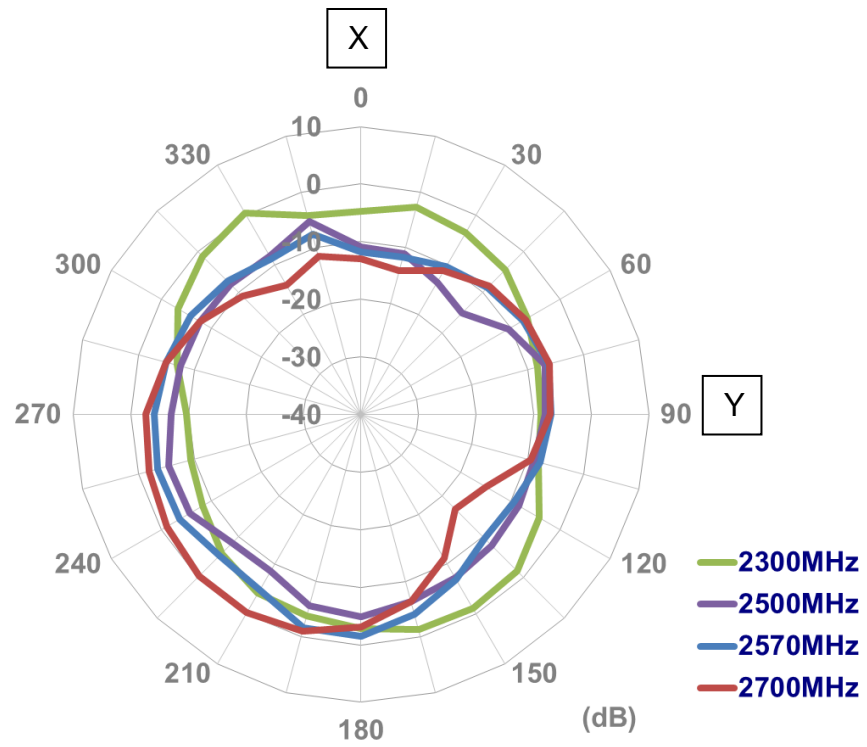

#### 4.2.2 XZ Plane

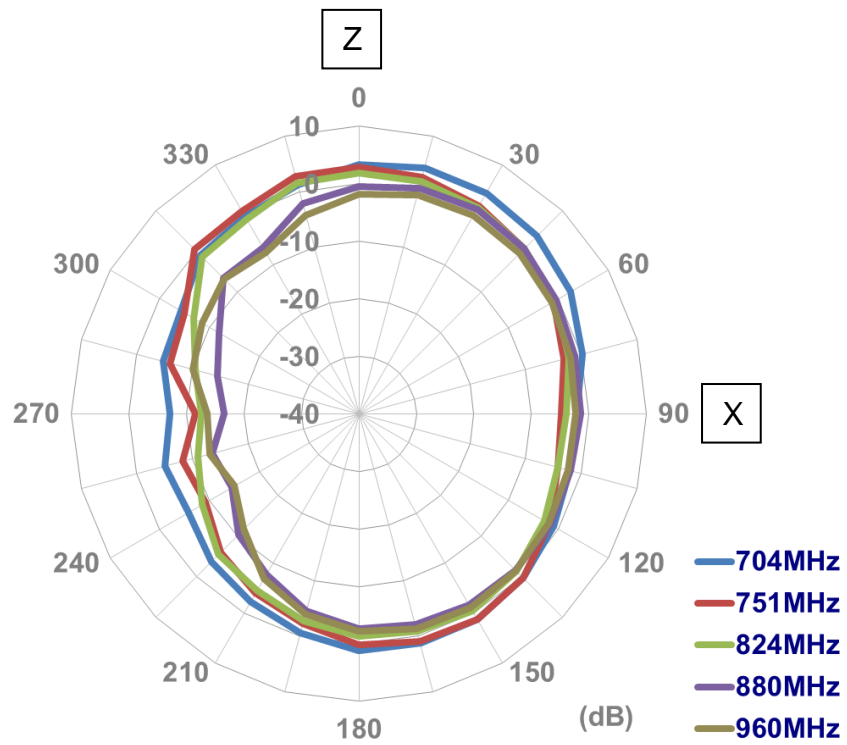

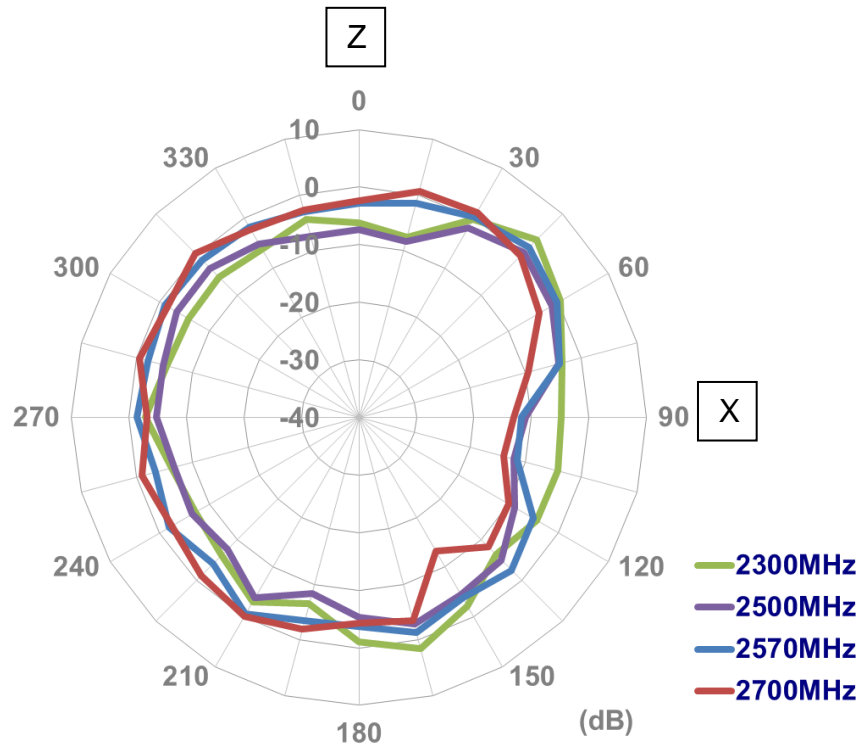
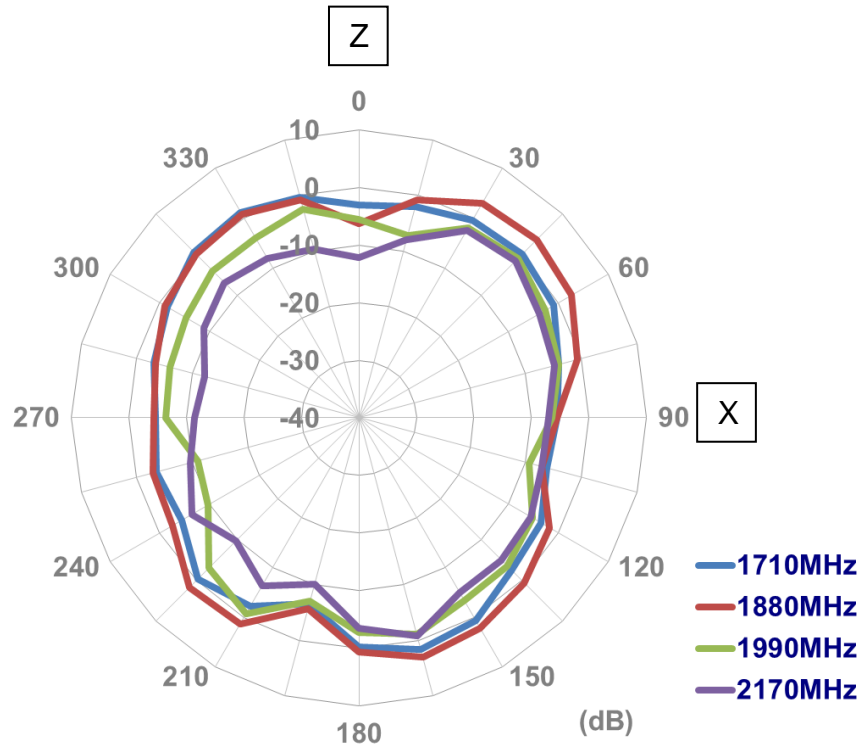

### 4.2.3 YZ Plane

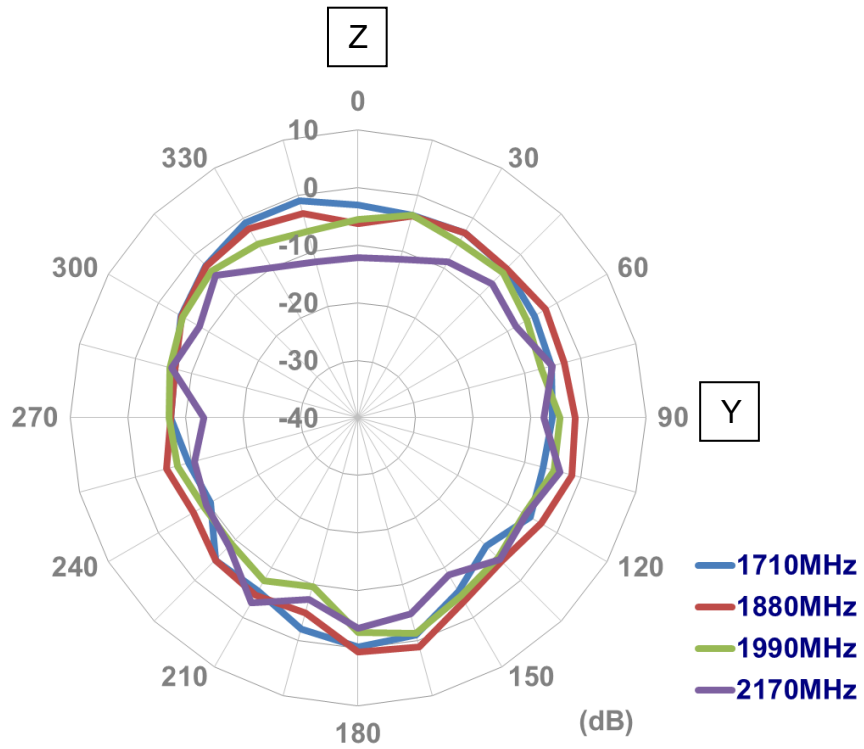
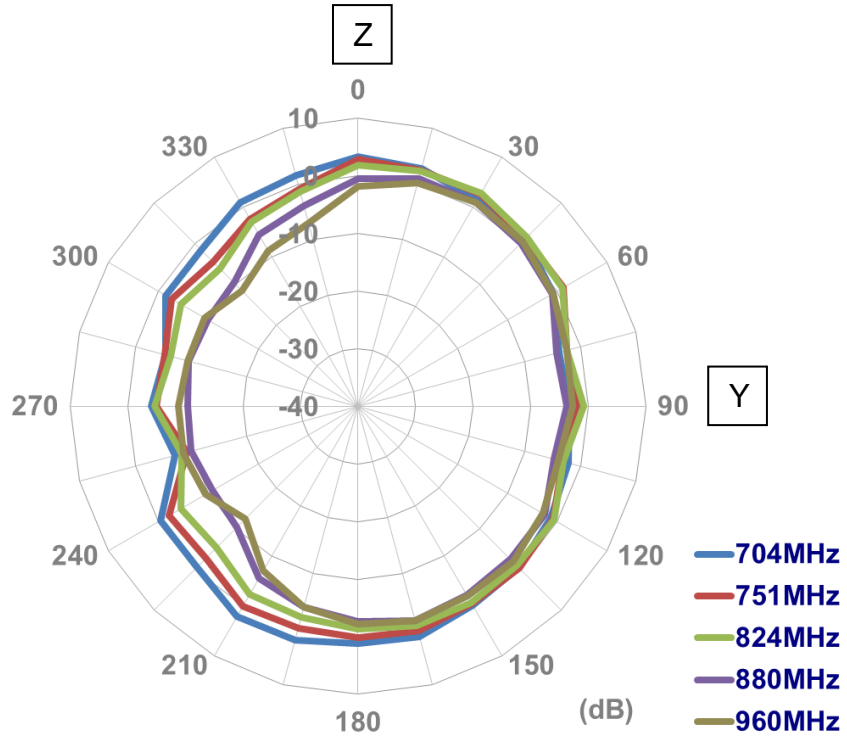

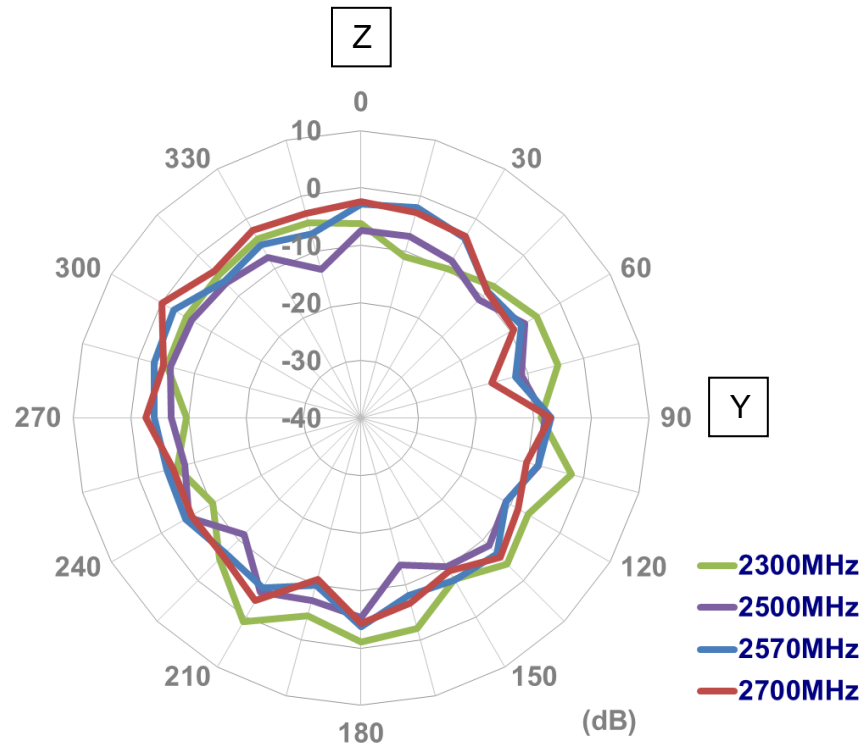

### 4.3 LTE MIMO 1 (3D Radiation Pattern)

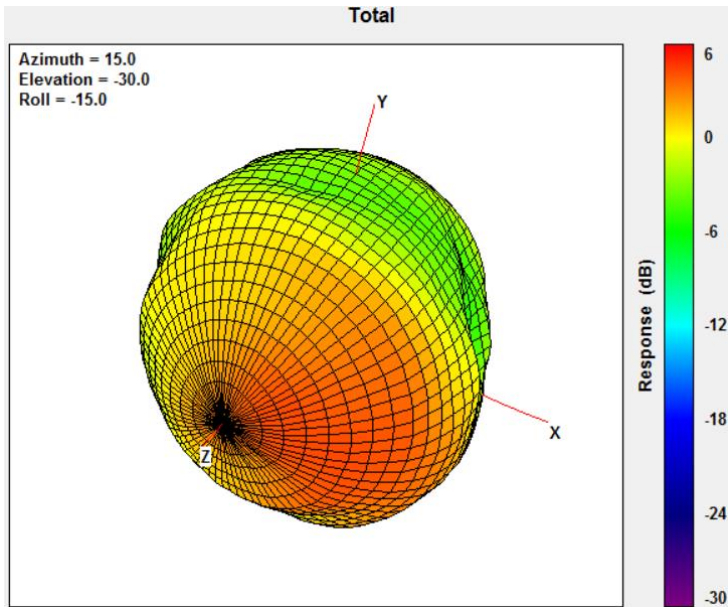

704MHz

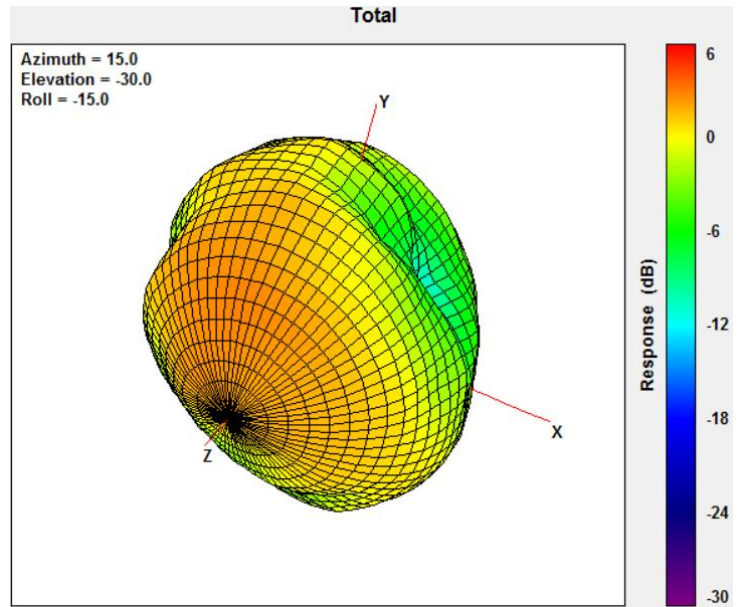

824MHz

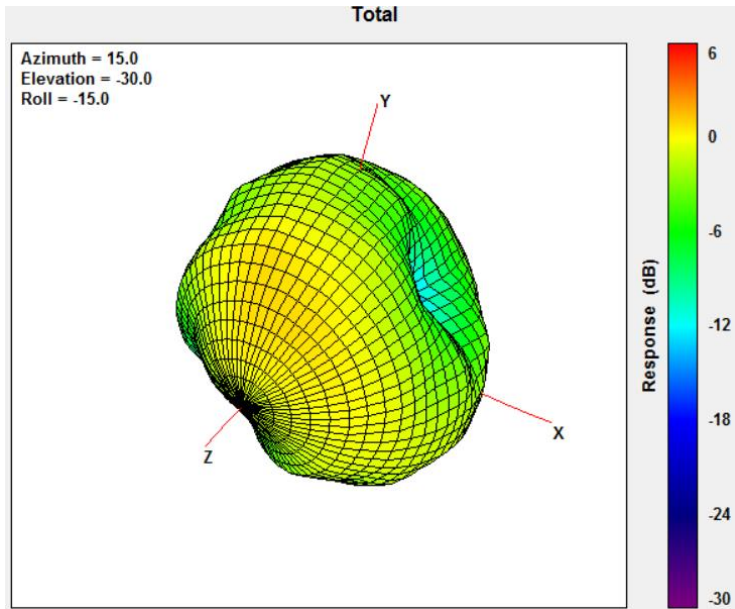

960MHz

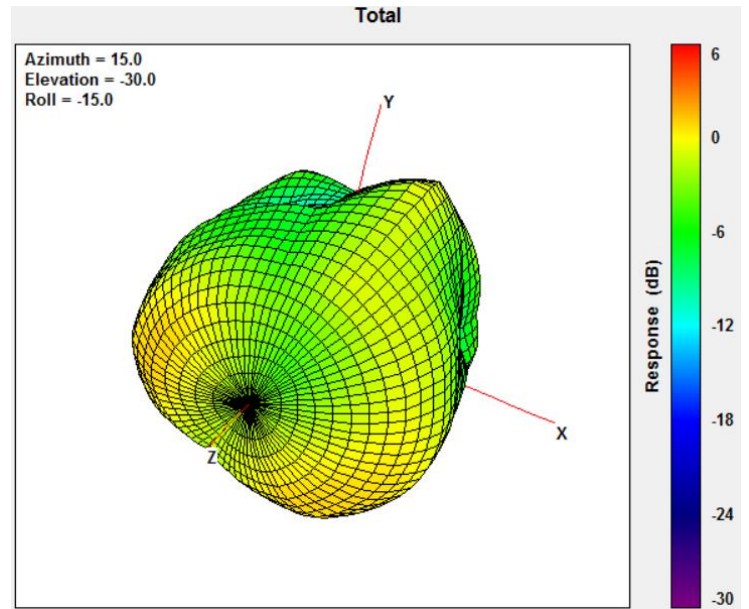

1710MHz

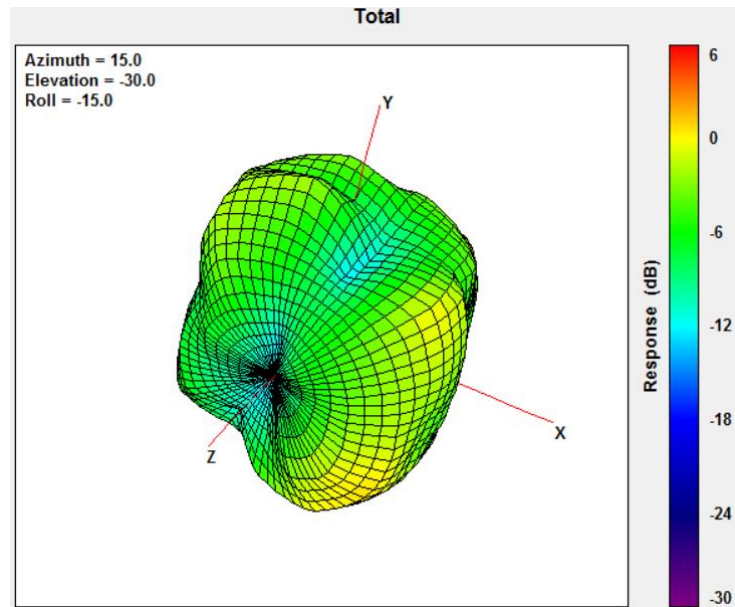

2170MHz

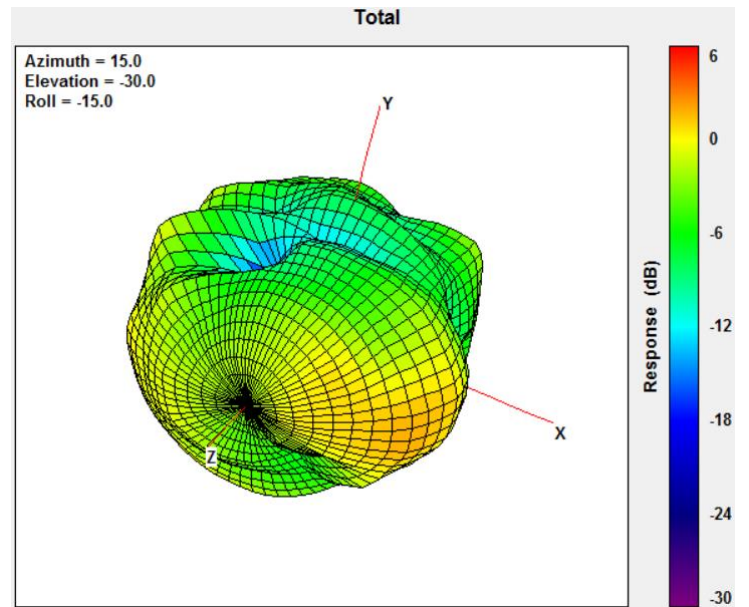

2600MHz

## 4.4 LTE MIMO2 (2D Radiation Pattern)

### 4.4.1 XY Plane

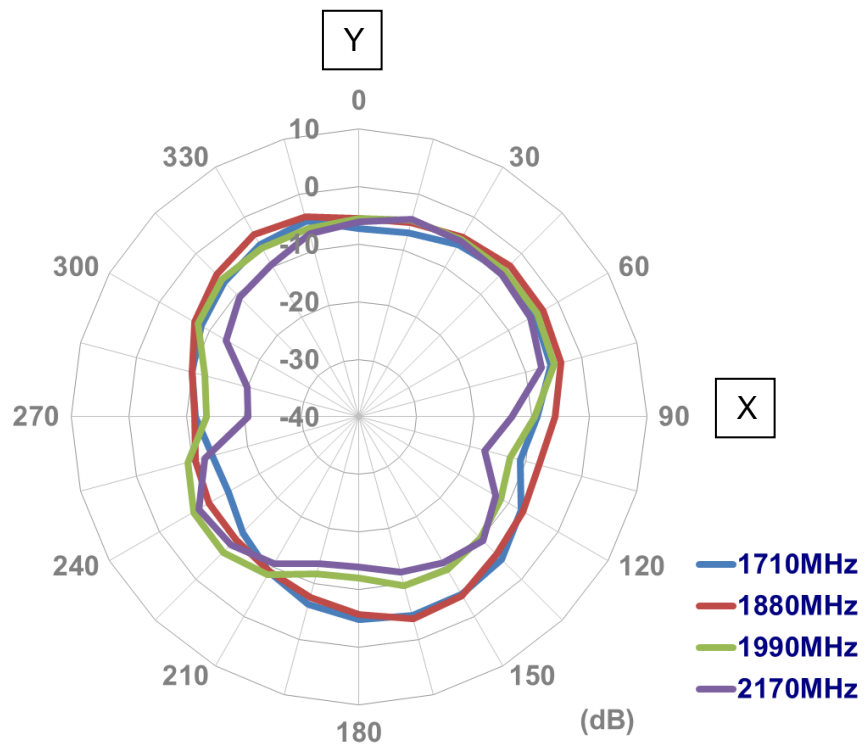
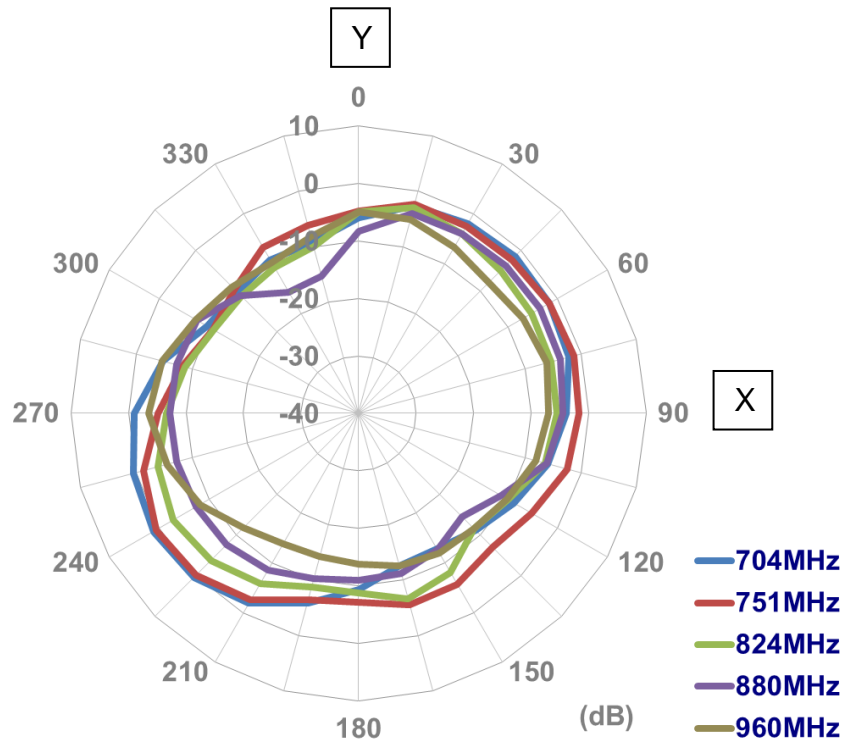



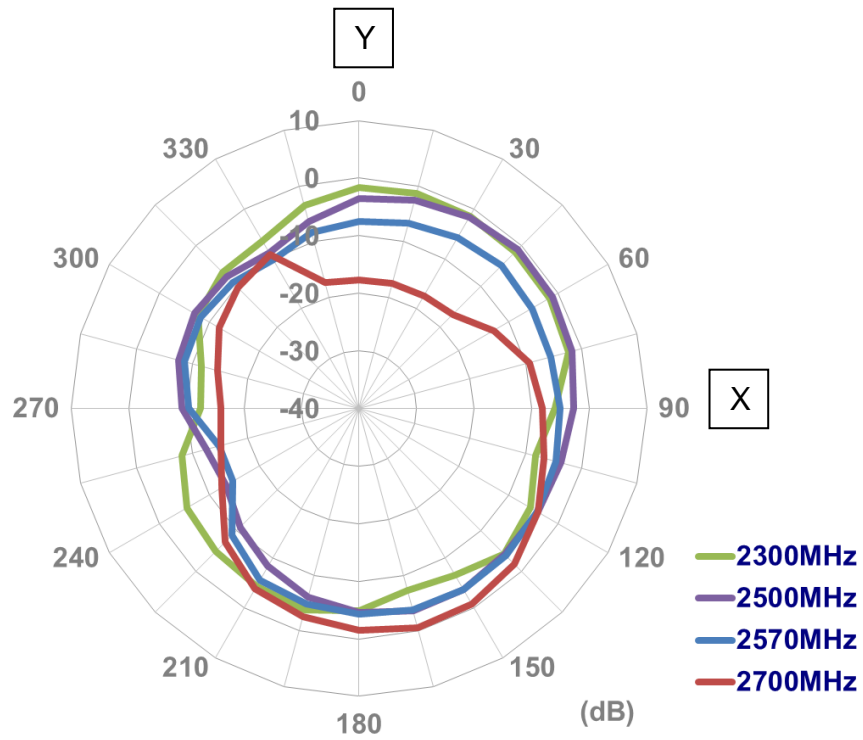

#### 4.4.2 XZ Plane

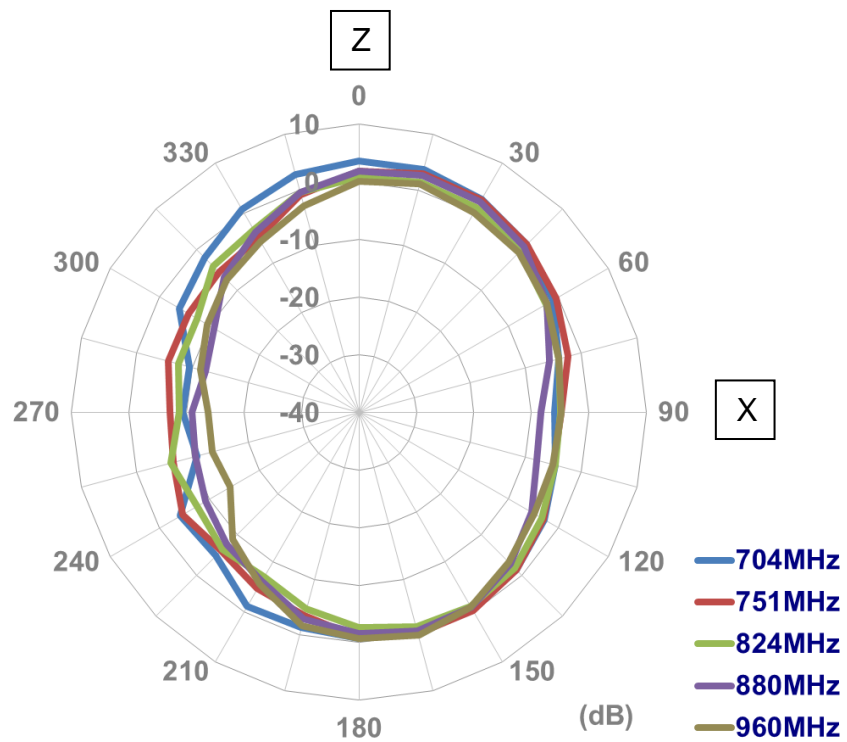

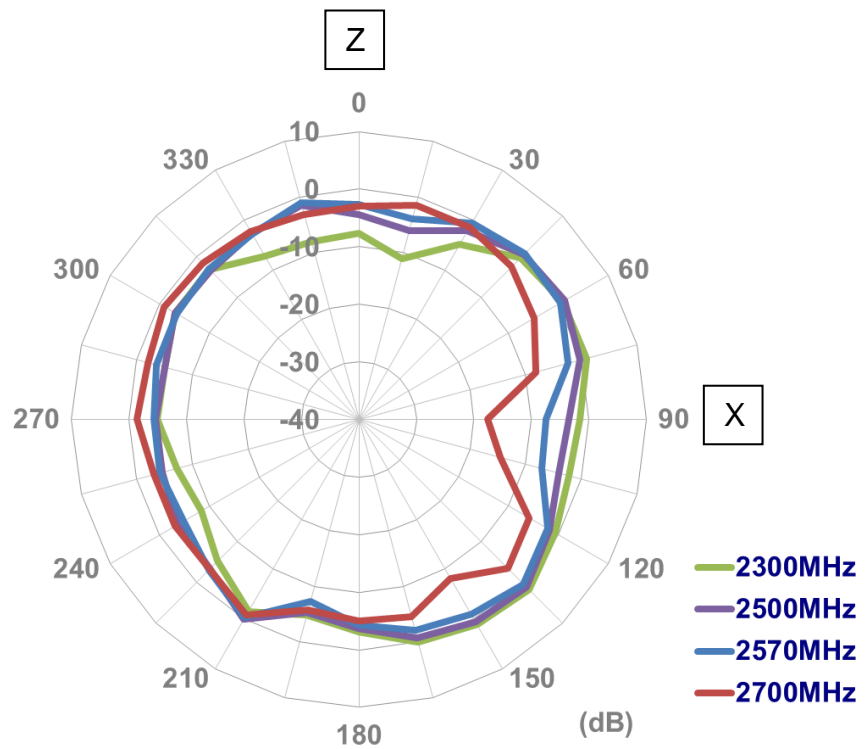
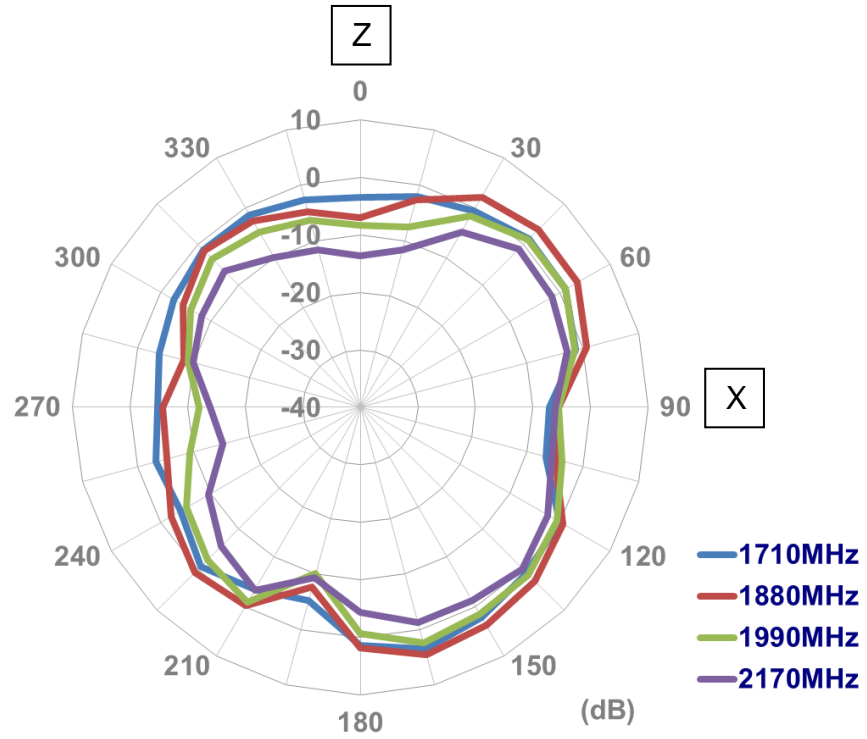



### 4.4.3 YZ Plane

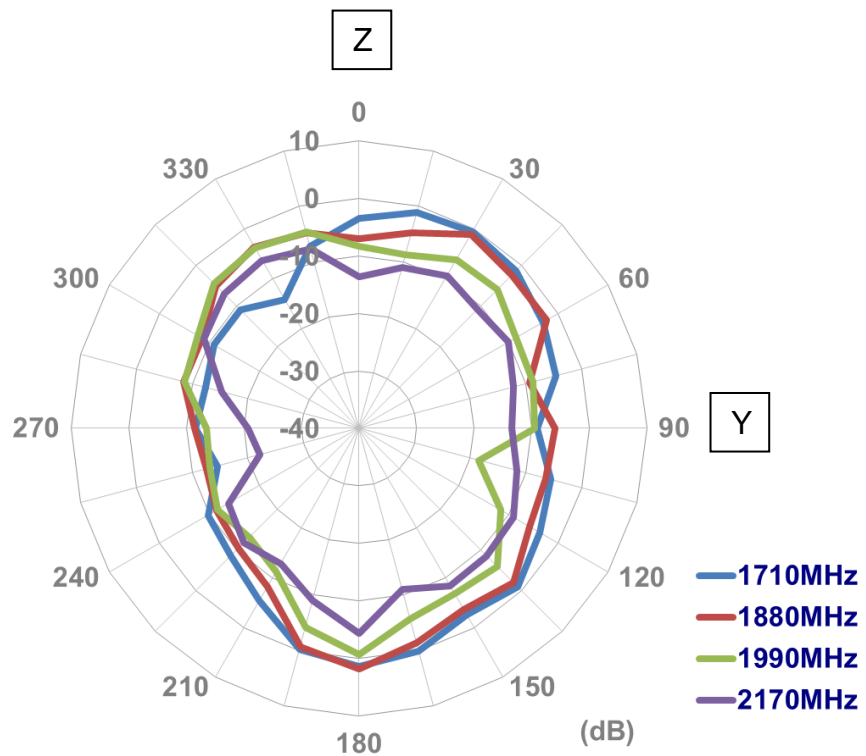
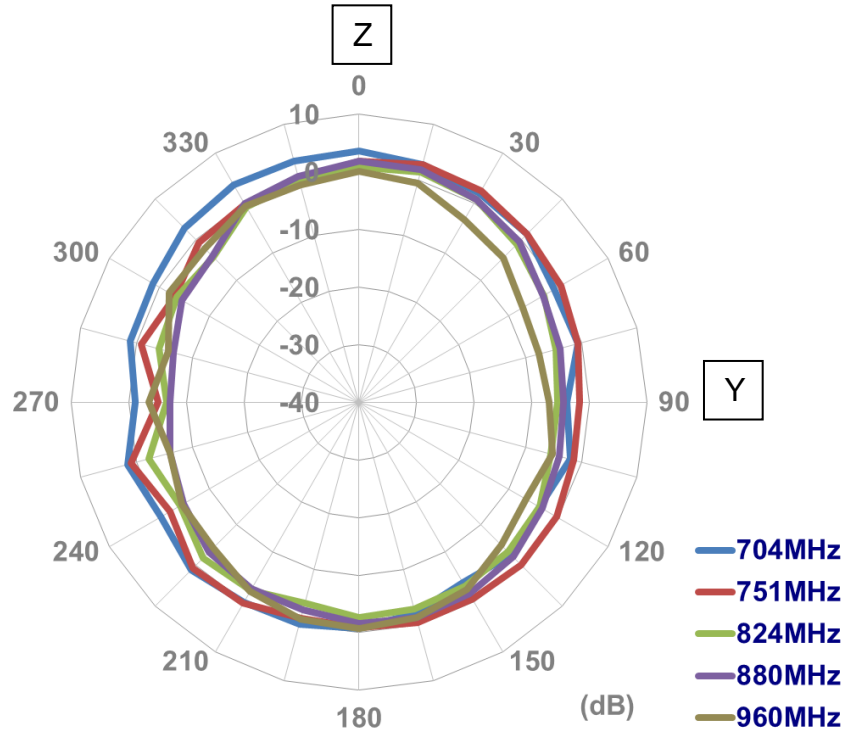

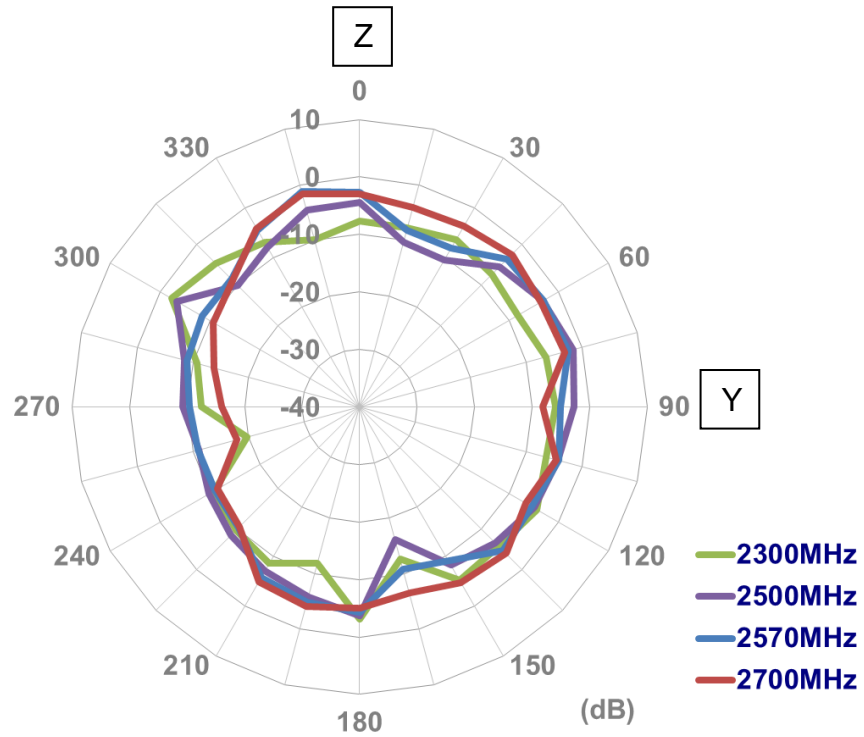

### 4.5 LTE MIMO 2 (3D Radiation Pattern)

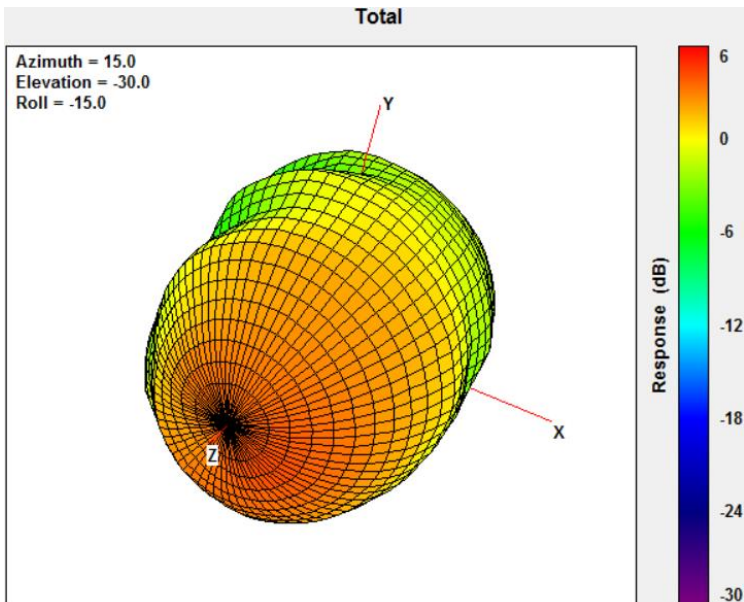

704MHz

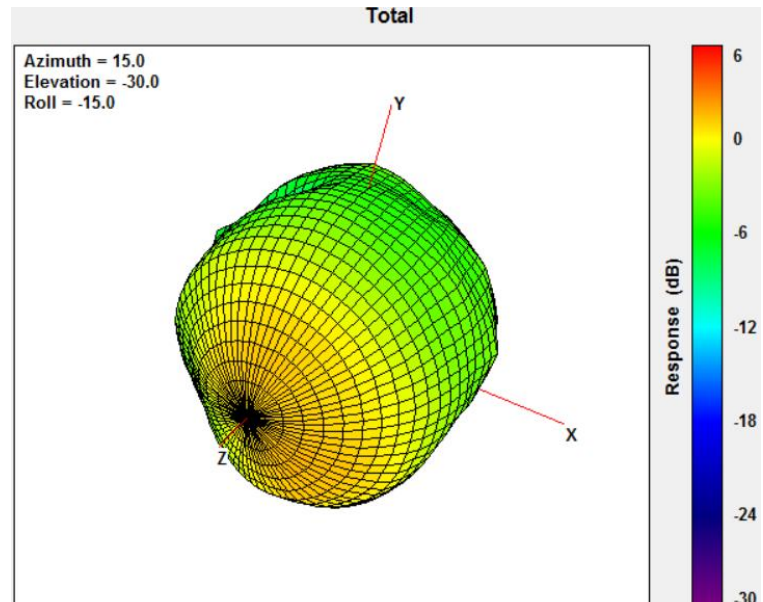

824MHz

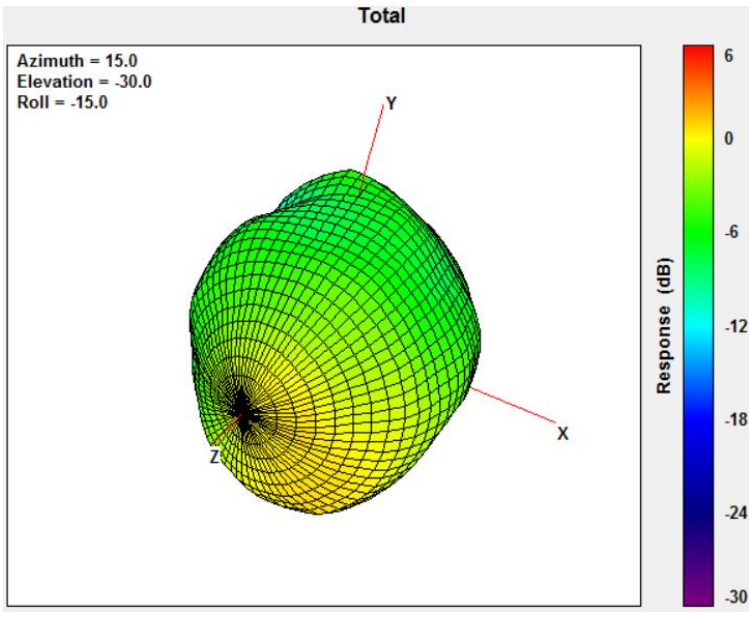

960MHz

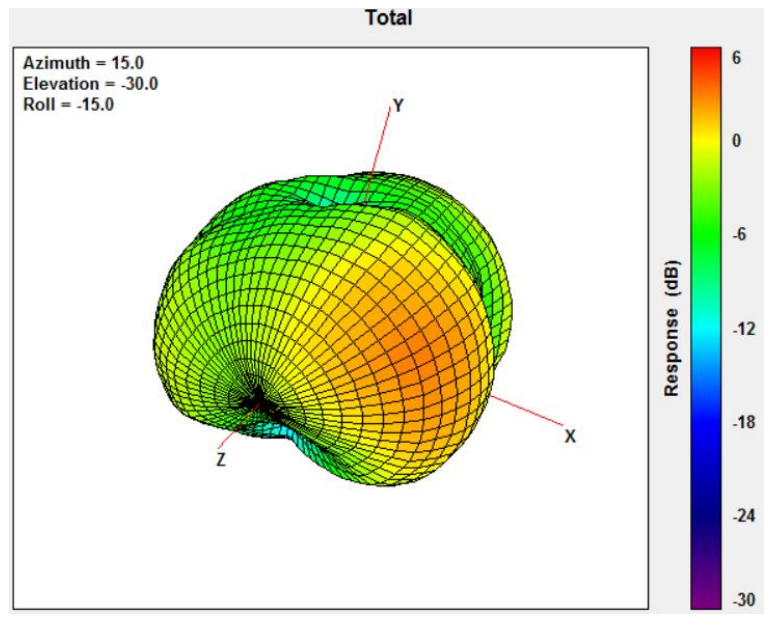

1710MHz

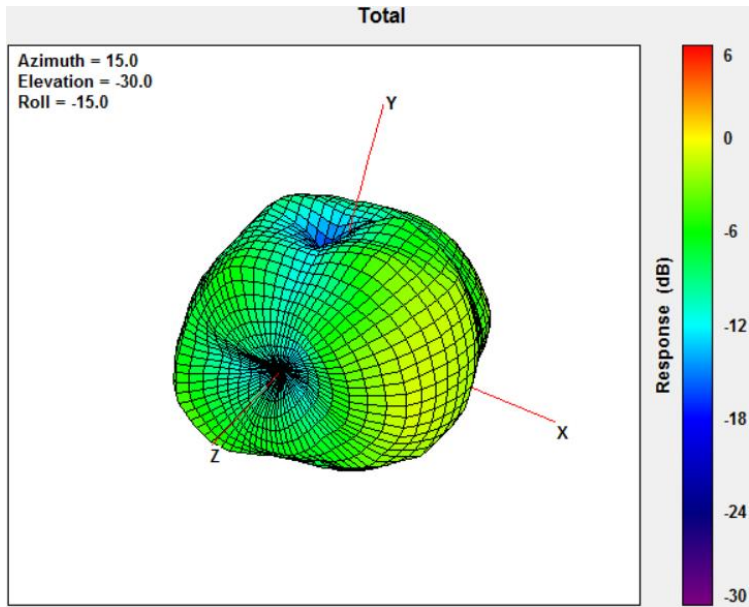

2170MHz

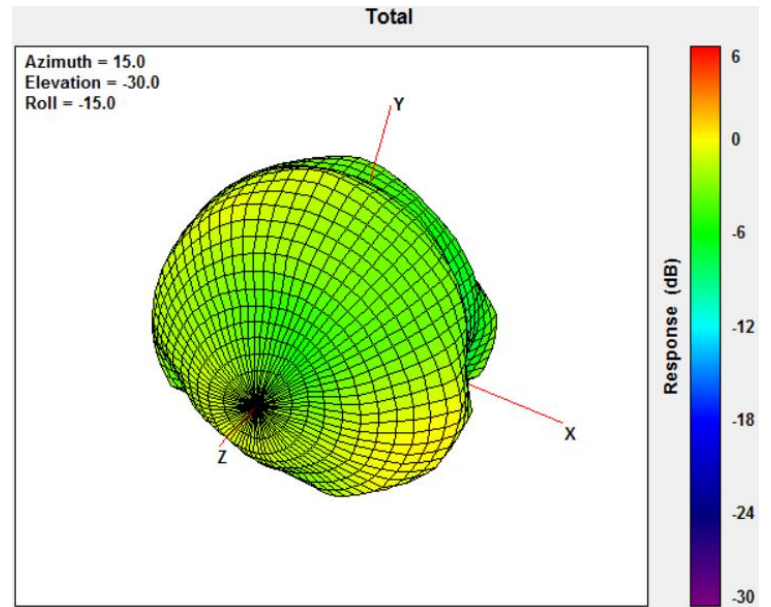

2600MHz

## 5. Mechanical Drawing

**Wall Mount to Antenna - Front View**

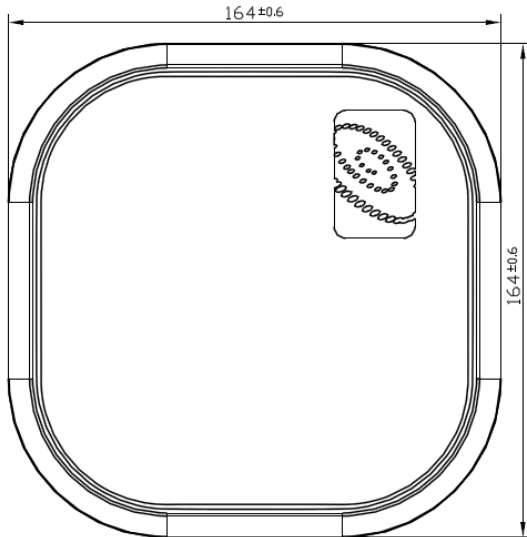

**Wall Mount to Antenna - Back View**

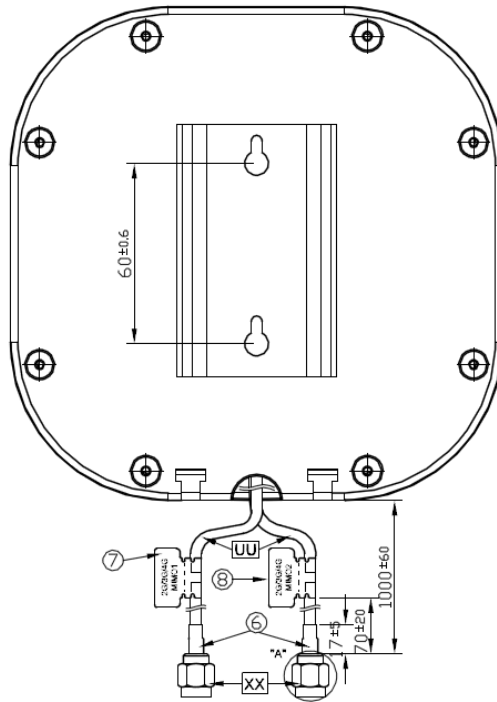

**Wall Mount to Antenna - Side View**

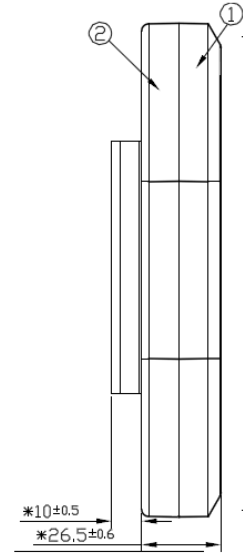

**Stand - Side View**

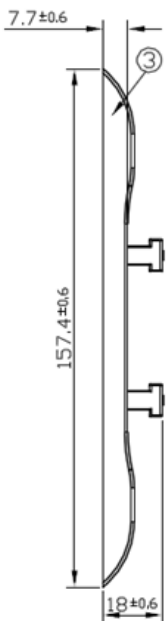

**Stand - Top View**

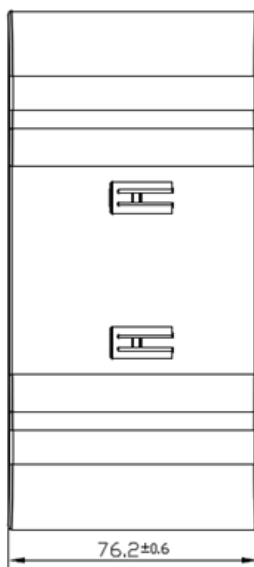

**Antenna Desktop Stand- Total Height**

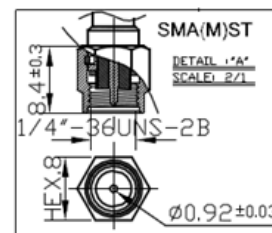
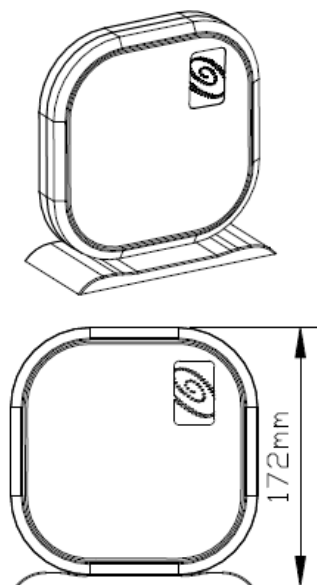

Name	Material	Finish	QTY
1 LMA100 Housing Top	PC+ABS	Black	1
2 LMA100 Housing Base	PC+ABS	Black	1
3 LMA100 Bracket	PC+ABS	Black	1
4 Φ4*25L Screw	Steel	Ni-Zn Plated	2
5 Φ6*24L Wall Mount Stud	Nylon	White	2
6 Cable Rubber	Silicone Rubber	Black	1
7 Heat Shrink Tube (CFD200)	PE	Black	2
8 2G/3G/4G MIMO1 Label	Coated Paper	Gray	1
9 2G/3G/4G MIMO2 Label	Coated Paper	White	1
Name	Spec	Finish	QTY
UU Cable Type	CFD200	Black	2
XX Connector Type	SMA(M) ST	Gold	2

## 6. Packaging

### LMA100.A.BI.001

#### Packaging Specifications

1pc LMA100.A.BI.001 per small box  
 Box Dimensions - 235\*170\*110mm  
 Weight - 650g

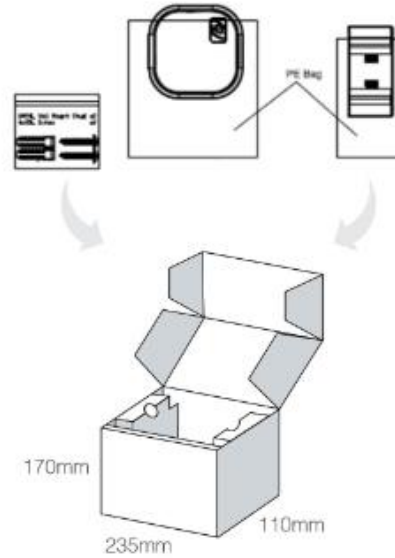

5 small boxes in one carton  
 Carton Dimensions - 360\*290\*260mm  
 Weight - 3.8Kg

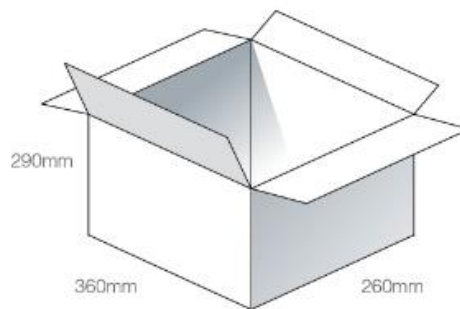

Pallet Dimensions 1100\*1100\*1290mm  
 48 Cartons per Pallet  
 12 Cartons per layer  
 4 Layers

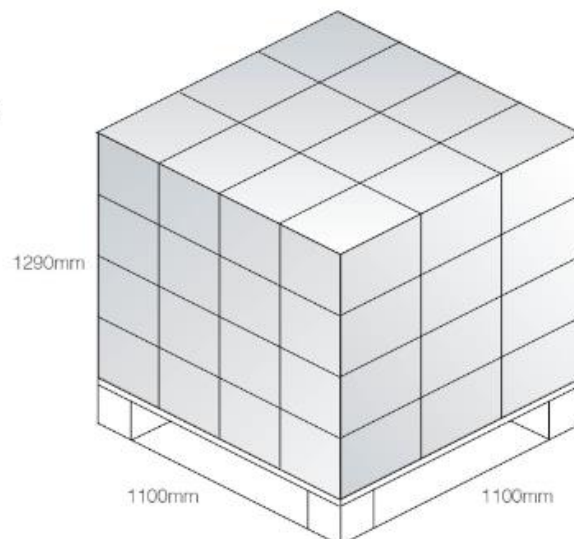

## 7. Installation Instructions

### 7.1 Package Contents

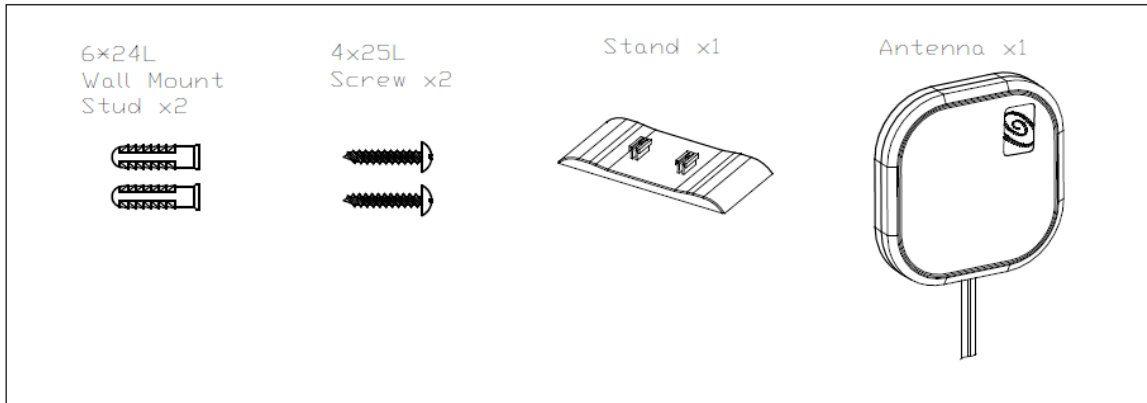

### 7.2 Desktop Stand Installation

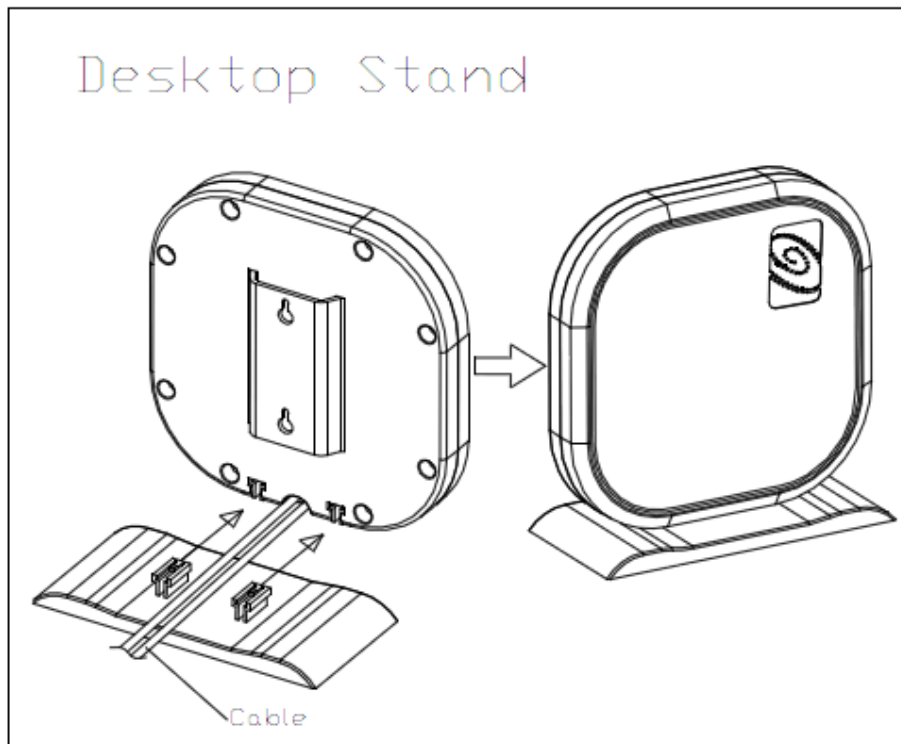



### 7.3 Wall Mount Installation

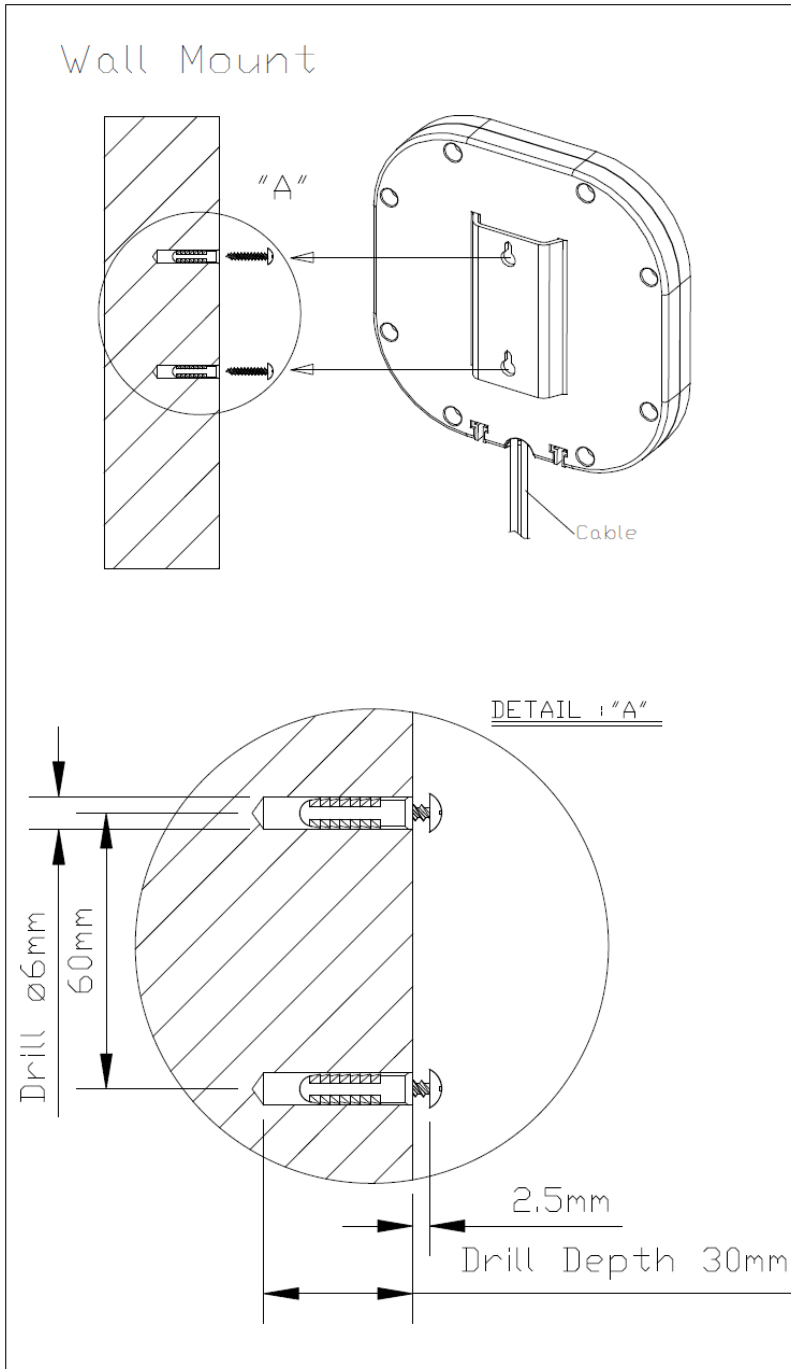

## 8. Application Note

The LMA.100 antenna performance with different cable lengths is shown below.

### 8.1 Isolation (Insertion Loss)

#### 8.1.1 S21

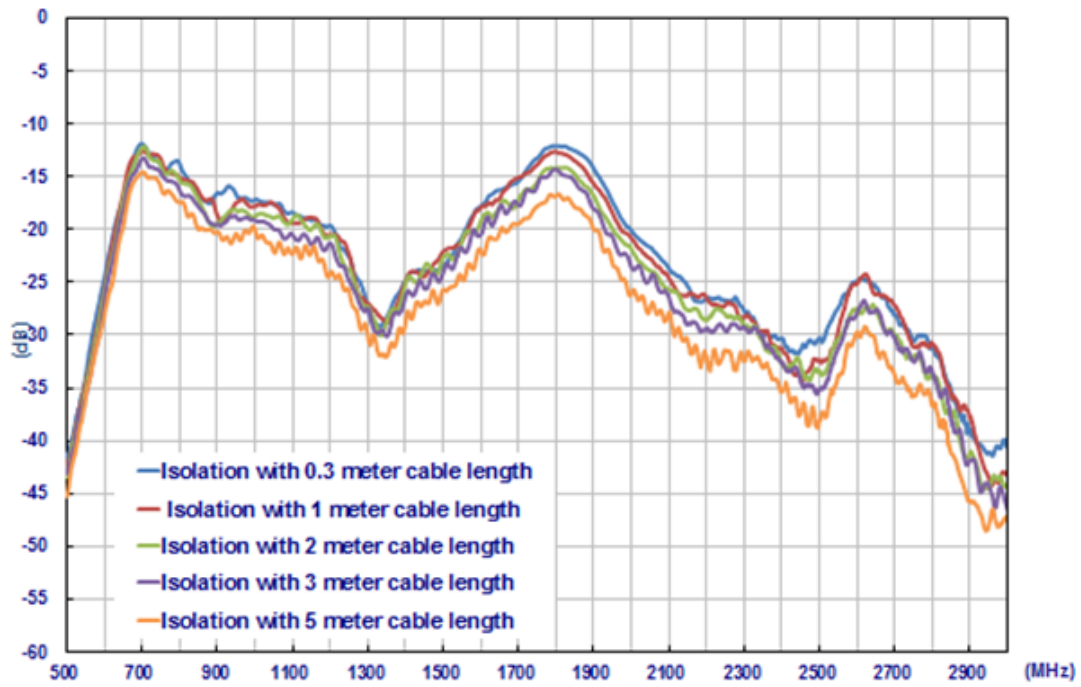



## 8.2 Return Loss

### 8.2.1 MIMO1

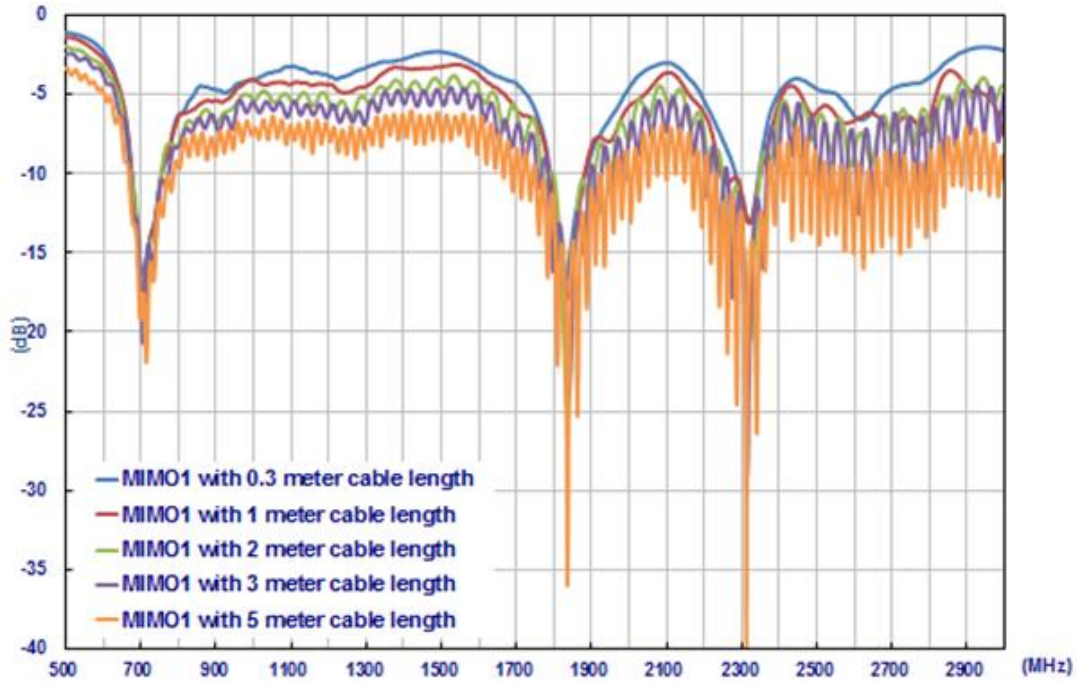

### 8.2.2 MIMO2

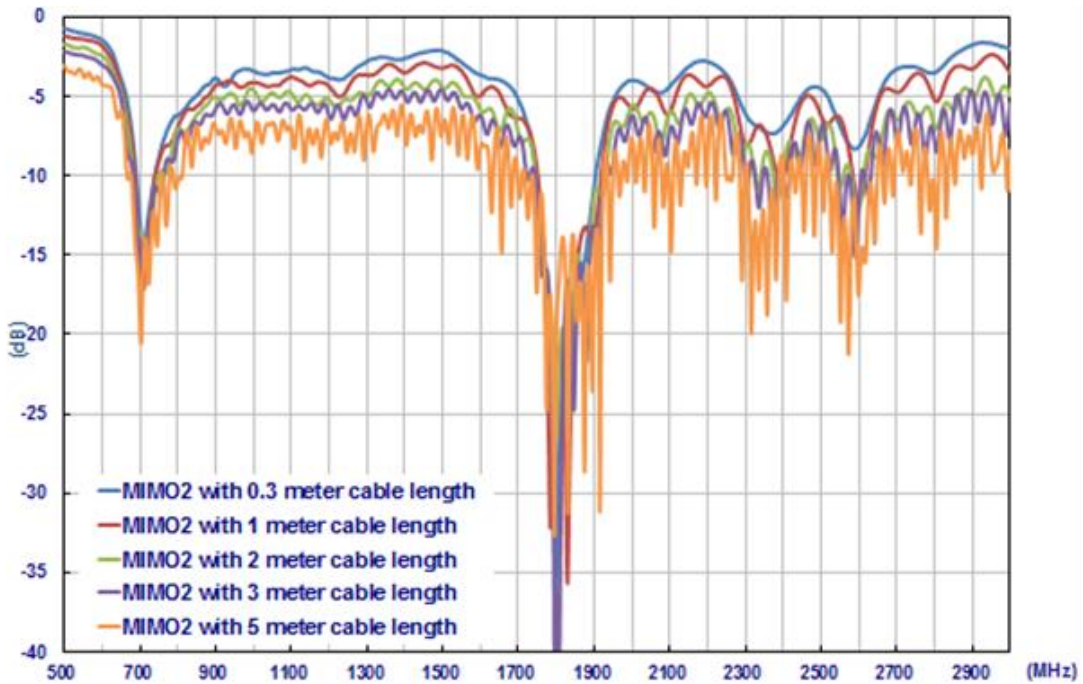

## 8.3 Efficiency

### 8.3.1 MIMO1

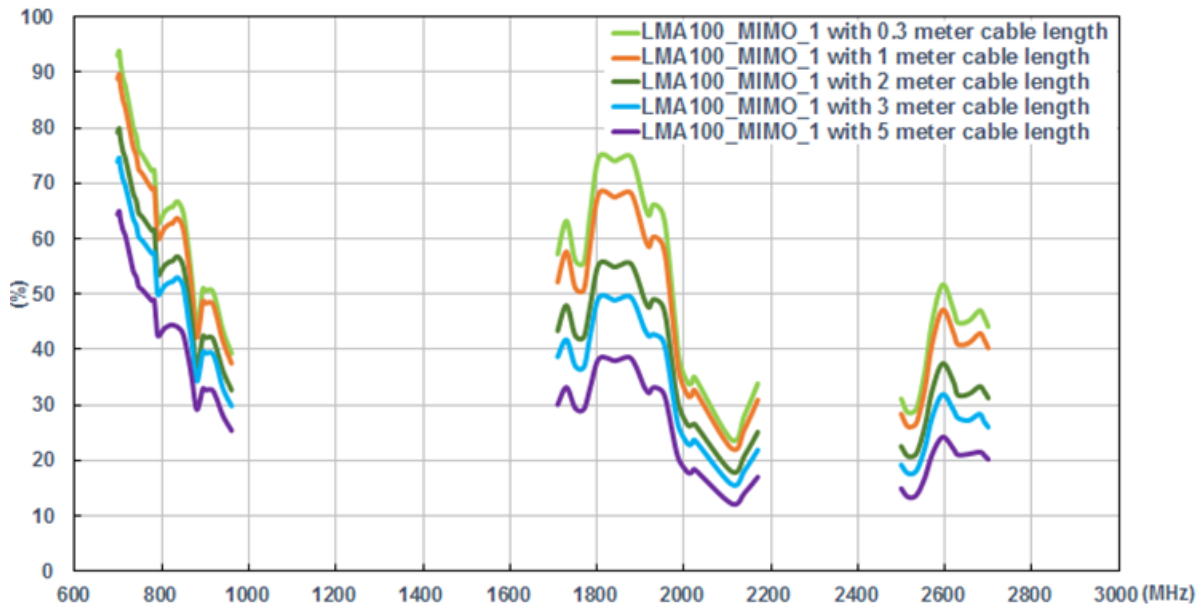

### 8.3.2 MIMO2

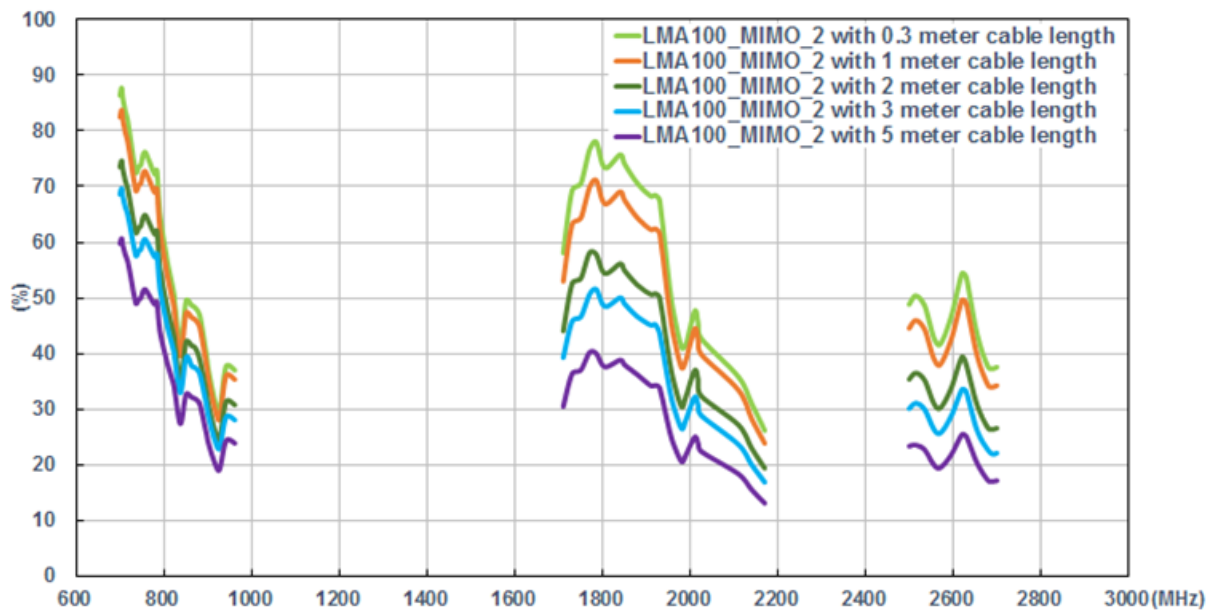

## 8.4 Average Gain

### 8.4.1 MIMO1

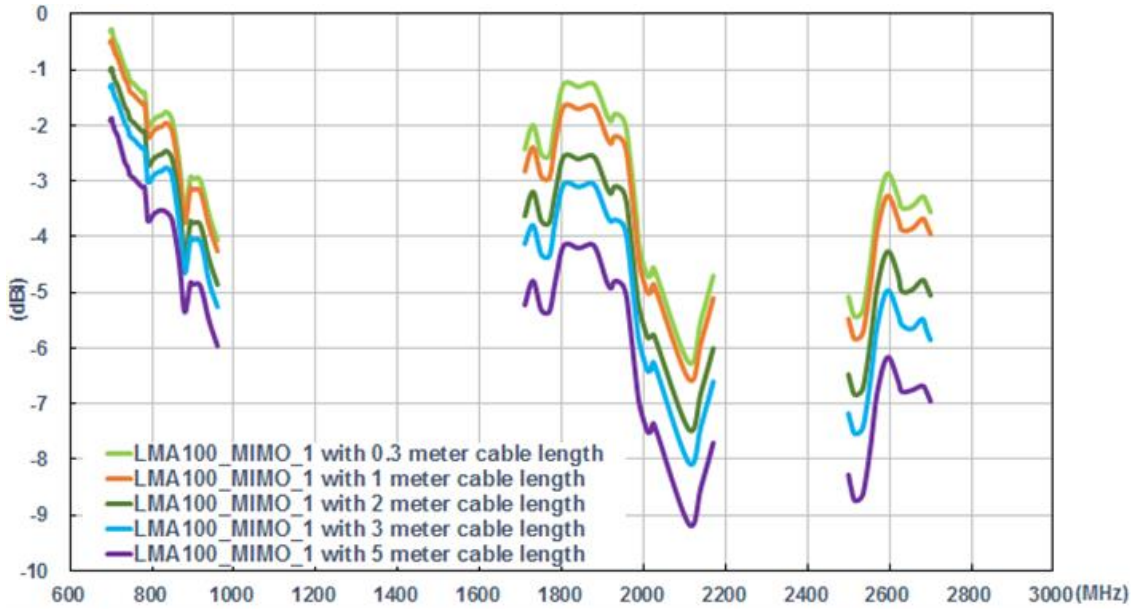

### 8.4.2 MIMO2

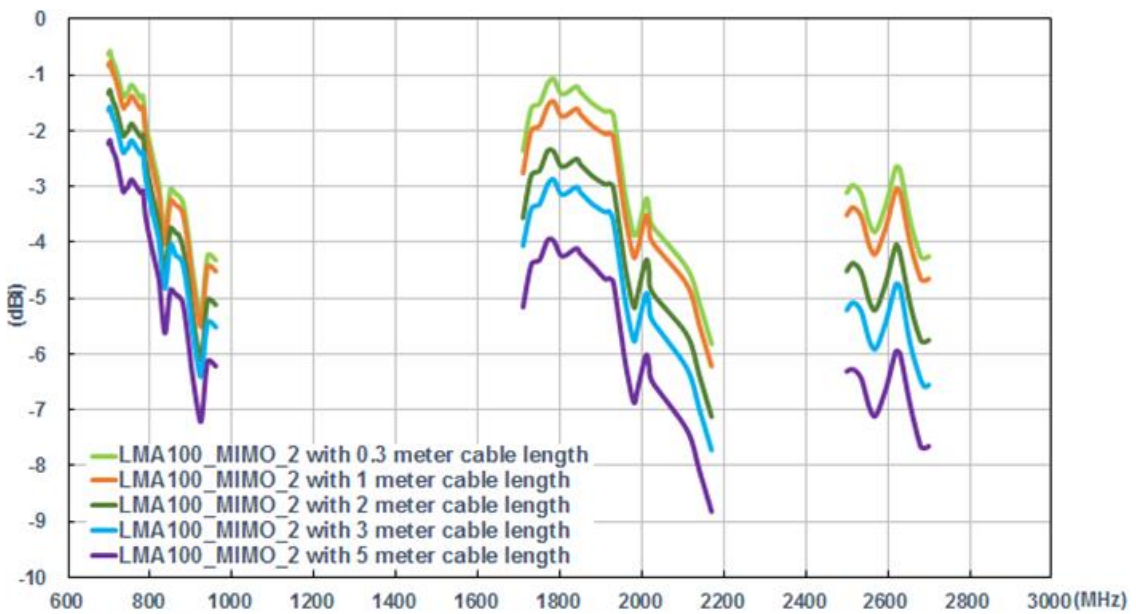

## 8.5 Peak Gain

### 8.5.1 MIMO1

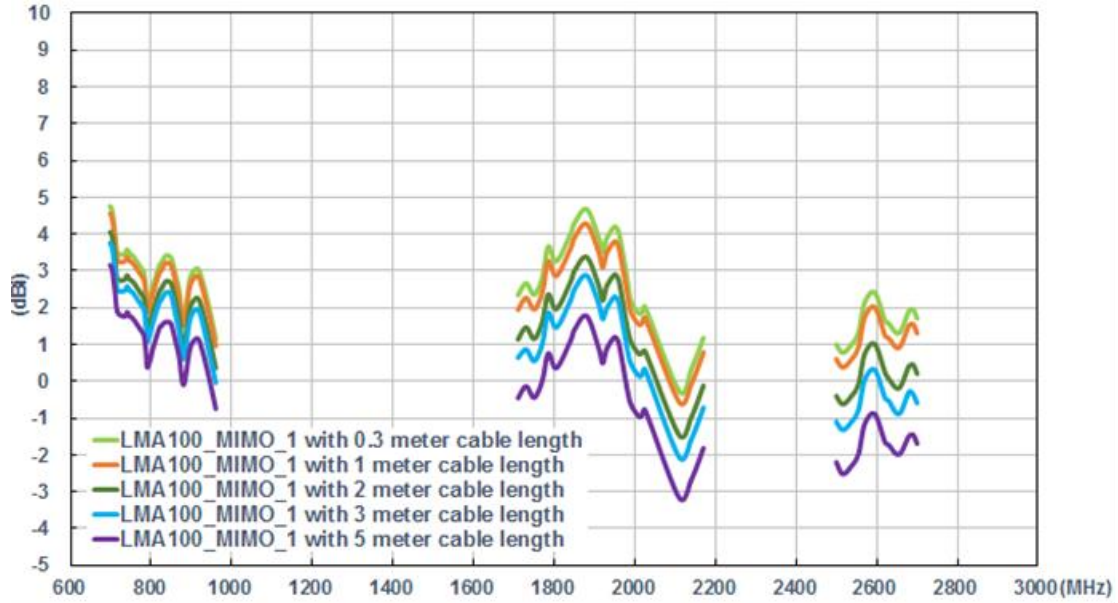

### 8.5.2 MIMO2

