

## High Voltage, Input Rectifier Diode, 20 A

**TO-220 FULL-PAK**

### FEATURES

- Very low forward voltage drop
- 150 °C max. operating junction temperature
- Glass passivated pellet chip junction
- Designed and qualified according to JEDEC®-JESD 47
- Fully isolated package ( $V_{INS} = 2500 V_{RMS}$ )
- UL E78996 approved
- Material categorization: for definitions of compliance please see [www.vishay.com/doc?99912](http://www.vishay.com/doc?99912)

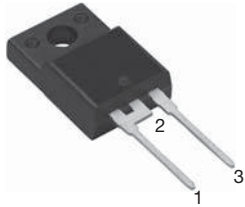
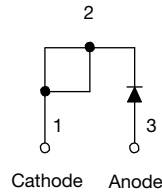

PRODUCT SUMMARY	
Package	TO-220FP
$I_{F(AV)}$	20 A
$V_R$	800 V to 1200 V
$V_F$ at $I_F$	1.1 V
$I_{FSM}$	300 A
$T_J$ max.	150 °C
Diode variation	Single die

### APPLICATIONS

- Input rectification
- Vishay Semiconductors switches and output rectifiers which are available in identical package outlines

### DESCRIPTION

High voltage rectifiers optimized for very low forward voltage drop with moderate leakage.

These devices are intended for use in main rectification (single or three phase bridge).

OUTPUT CURRENT IN TYPICAL APPLICATIONS			
APPLICATIONS	SINGLE-PHASE BRIDGE	THREE-PHASE BRIDGE	UNITS
Capacitive input filter $T_A = 55$ °C, $T_J = 125$ °C common heatsink of 1 °C/W	18	22	A

MAJOR RATINGS AND CHARACTERISTICS			
SYMBOL	CHARACTERISTICS	VALUES	UNITS
$I_{F(AV)}$	Sinusoidal waveform	20	A
$V_{RRM}$	Range	800/1200	V
$I_{FSM}$		300	A
$V_F$	10 A, $T_J = 25$ °C	1.0	V
$T_J$		-40 to +150	°C

VOLTAGE RATINGS			
PART NUMBER	$V_{RRM}$ , MAXIMUM PEAK REVERSE VOLTAGE V	$V_{RSM}$ , MAXIMUM NON-REPETITIVE PEAK REVERSE VOLTAGE V	$I_{RRM}$ AT 150 °C mA
VS-20ETS08FPPbF, VS-20ETS08FP-M3	800	900	1
VS-20ETS12FPPbF, VS-20ETS12FP-M3	1200	1300	



<b>ABSOLUTE MAXIMUM RATINGS</b>				
PARAMETER	SYMBOL	TEST CONDITIONS	VALUES	UNITS
Maximum average forward current	$I_{F(AV)}$	$T_C = 51\text{ }^\circ\text{C}$ , 180° conduction half sine wave	20	A
Maximum peak one cycle non-repetitive surge current	$I_{FSM}$	10 ms sine pulse, rated $V_{RRM}$ applied	250	
		10 ms sine pulse, no voltage reapplied	300	
Maximum $I^2t$ for fusing	$I^2t$	10 ms sine pulse, rated $V_{RRM}$ applied	316	A <sup>2</sup> s
		10 ms sine pulse, no voltage reapplied	442	
Maximum $I^2\sqrt{t}$ for fusing	$I^2\sqrt{t}$	$t = 0.1\text{ ms to }10\text{ ms}$ , no voltage reapplied	4420	A <sup>2</sup> √s

<b>ELECTRICAL SPECIFICATIONS</b>					
PARAMETER	SYMBOL	TEST CONDITIONS	VALUES	UNITS	
Maximum forward voltage drop	$V_{FM}$	20 A, $T_J = 25\text{ }^\circ\text{C}$	1.1	V	
Forward slope resistance	$r_t$	$T_J = 150\text{ }^\circ\text{C}$	10.4	mΩ	
Threshold voltage	$V_{F(TO)}$		0.85	V	
Maximum reverse leakage current	$I_{RM}$	$V_R = \text{Rated } V_{RRM}$	$T_J = 25\text{ }^\circ\text{C}$	0.1	mA
			$T_J = 150\text{ }^\circ\text{C}$	1.0	

<b>THERMAL - MECHANICAL SPECIFICATIONS</b>				
PARAMETER	SYMBOL	TEST CONDITIONS	VALUES	UNITS
Maximum junction and storage temperature range	$T_J, T_{Stg}$		-40 to +150	°C
Maximum thermal resistance, junction to case	$R_{thJC}$	DC operation	2.8	°C/W
Maximum thermal resistance, junction to ambient	$R_{thJA}$		62	
Typical thermal resistance, case to heatsink	$R_{thCS}$	Mounting surface, smooth, and greased	0.5	
Approximate weight			2	g
			0.07	oz.
Mounting torque	minimum		6.0 (5.0)	kgf · cm (lbf · in)
	maximum		12 (10)	
Marking device		Case style TO-220 FULL-PAK	20ETS08FP	
			20ETS12FP	

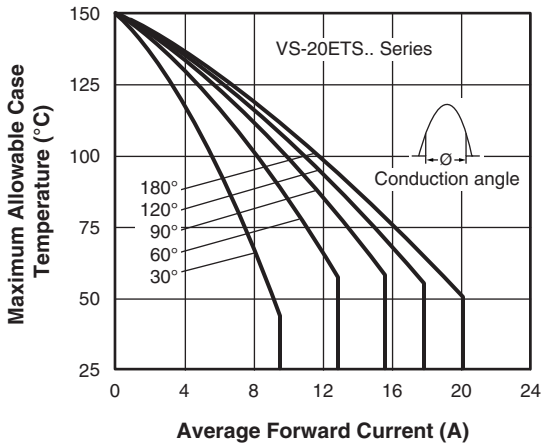

Fig. 1 - Current Rating Characteristics

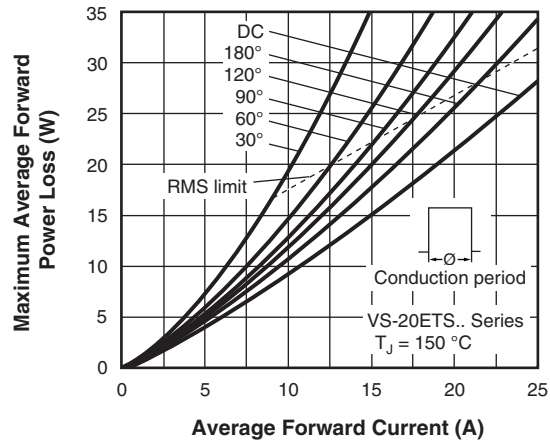

Fig. 4 - Forward Power Loss Characteristics

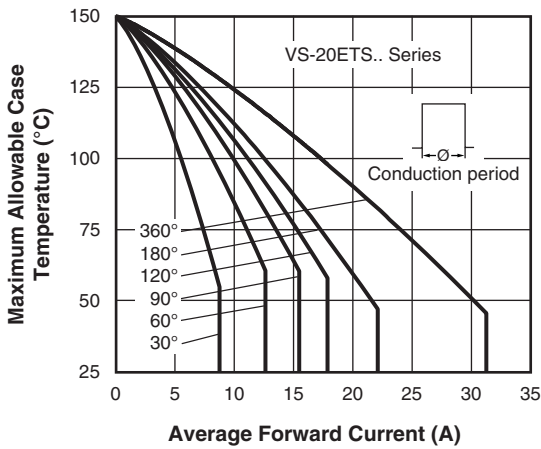

Fig. 2 - Current Rating Characteristics

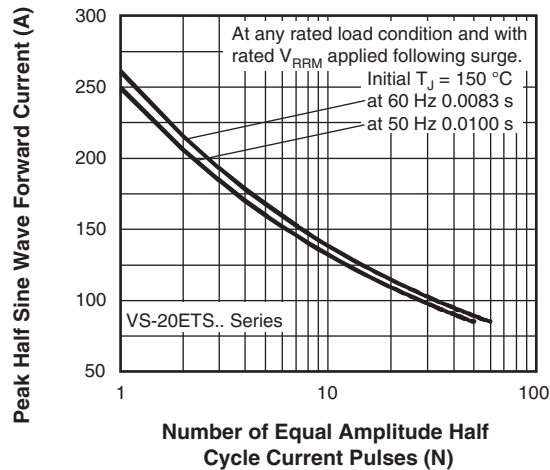

Fig. 5 - Maximum Non-Repetitive Surge Current

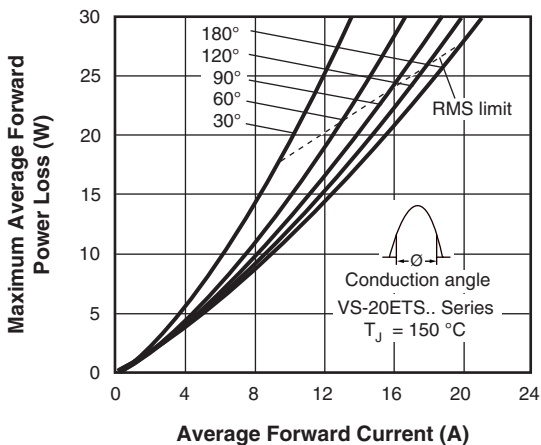

Fig. 3 - Forward Power Loss Characteristics

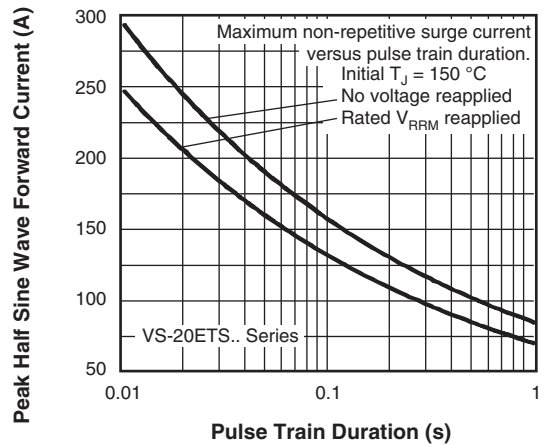

Fig. 6 - Maximum Non-Repetitive Surge Current

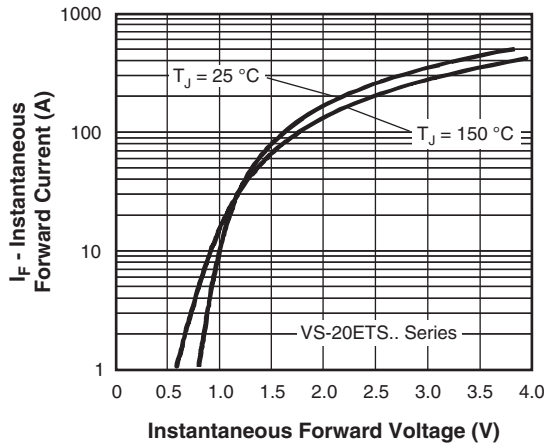

Fig. 7 - Forward Voltage Drop Characteristics

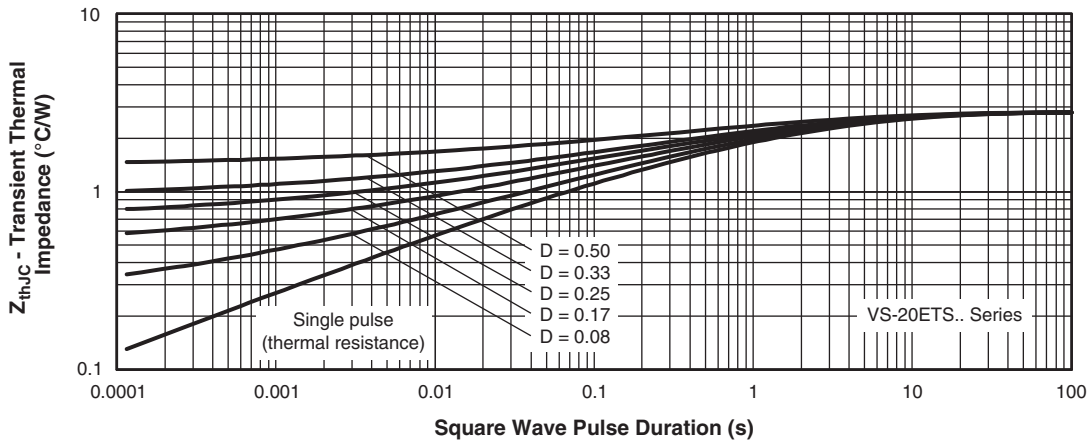

Fig. 8 - Thermal Impedance  $Z_{thJC}$  Characteristics



## ORDERING INFORMATION TABLE

Device code	<b>VS-</b>	<b>20</b>	<b>E</b>	<b>T</b>	<b>S</b>	<b>12</b>	<b>FP</b>	<b>PbF</b>
	①	②	③	④	⑤	⑥	⑦	⑧

- 1** - Vishay Semiconductors product
- 2** - Current rating (20 = 20 A)
- Circuit configuration:
- 3** E = single diode
- Package:
- 4** T = TO-220
- Type of silicon:
- 5** S = standard recovery rectifier
- 6** - Voltage ratings 08 = 800 V  
12 = 1200 V
- 7** - FULL-PAK
- 8** - Environmental digit:

PbF = lead (Pb)-free and RoHS-compliant  
-M3 = halogen-free, RoHS-compliant, and terminations lead (Pb)-free

ORDERING INFORMATION (Example)			
PREFERRED P/N	QUANTITY PER T/R	MINIMUM ORDER QUANTITY	PACKAGING DESCRIPTION
VS-20ETS08FPPbF	50	1000	Antistatic plastic tubes
VS-20ETS08FP-M3	50	1000	Antistatic plastic tubes
VS-20ETS12FPPbF	50	1000	Antistatic plastic tubes
VS-20ETS12FP-M3	50	1000	Antistatic plastic tubes

LINKS TO RELATED DOCUMENTS	
Dimensions	<a href="http://www.vishay.com/doc?95005">www.vishay.com/doc?95005</a>
Part marking information	TO-220 FP PbF <a href="http://www.vishay.com/doc?95009">www.vishay.com/doc?95009</a>
	TO-220 FP -M3 <a href="http://www.vishay.com/doc?95440">www.vishay.com/doc?95440</a>



**DIMENSIONS** in millimeters

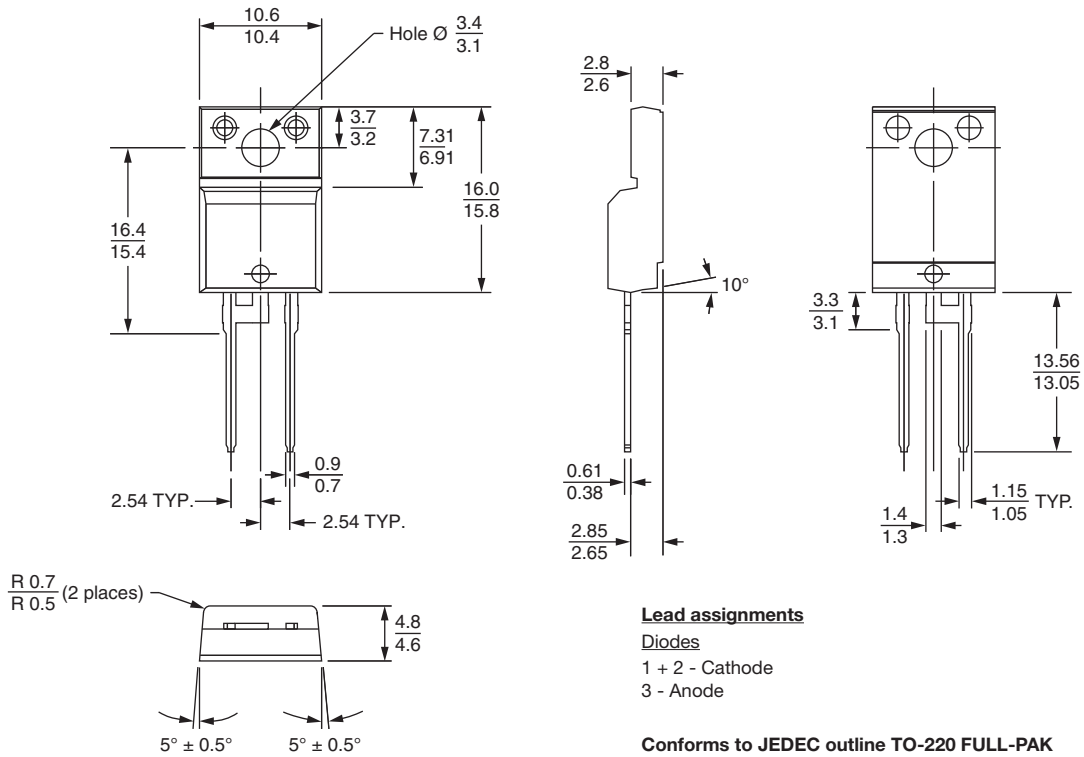



## **Disclaimer**

ALL PRODUCT, PRODUCT SPECIFICATIONS AND DATA ARE SUBJECT TO CHANGE WITHOUT NOTICE TO IMPROVE RELIABILITY, FUNCTION OR DESIGN OR OTHERWISE.

Vishay Intertechnology, Inc., its affiliates, agents, and employees, and all persons acting on its or their behalf (collectively, "Vishay"), disclaim any and all liability for any errors, inaccuracies or incompleteness contained in any datasheet or in any other disclosure relating to any product.

Vishay makes no warranty, representation or guarantee regarding the suitability of the products for any particular purpose or the continuing production of any product. To the maximum extent permitted by applicable law, Vishay disclaims (i) any and all liability arising out of the application or use of any product, (ii) any and all liability, including without limitation special, consequential or incidental damages, and (iii) any and all implied warranties, including warranties of fitness for particular purpose, non-infringement and merchantability.

Statements regarding the suitability of products for certain types of applications are based on Vishay's knowledge of typical requirements that are often placed on Vishay products in generic applications. Such statements are not binding statements about the suitability of products for a particular application. It is the customer's responsibility to validate that a particular product with the properties described in the product specification is suitable for use in a particular application. Parameters provided in datasheets and / or specifications may vary in different applications and performance may vary over time. All operating parameters, including typical parameters, must be validated for each customer application by the customer's technical experts. Product specifications do not expand or otherwise modify Vishay's terms and conditions of purchase, including but not limited to the warranty expressed therein.

Except as expressly indicated in writing, Vishay products are not designed for use in medical, life-saving, or life-sustaining applications or for any other application in which the failure of the Vishay product could result in personal injury or death. Customers using or selling Vishay products not expressly indicated for use in such applications do so at their own risk. Please contact authorized Vishay personnel to obtain written terms and conditions regarding products designed for such applications.

No license, express or implied, by estoppel or otherwise, to any intellectual property rights is granted by this document or by any conduct of Vishay. Product names and markings noted herein may be trademarks of their respective owners.